

A NEW TECHNOLOGY TO COMBAT OIL SPILLS ON WATER SURFACE USING A RIBBED-GROOVED DISC SKIMMER

نظام جديد لمكافحة تلوث الاسطح المائية بالبقع الزيتية باستخدام الاقراص الدوارة ذات النتوءات و التحويزات

NABIL A. S. EL-MINSHAWY¹

Ass. Prof., Mech. Power Eng. Dept., Suez Canal University

ملخص البحث

يتناول البحث دراسة مصلية على نموذج جديد لاستعادة الزيوت والنفط المنسرب للاسطح البحرية وذلك باستخدام الاقراص الدوارة بتعديل اسطحها من الاسطح المستوية الى اسطح ذات نتوءات ومجاري وذلك مع توظيف علم ميكانيكا الموائع لهذا الغرض. تم اختبار النموذج لكشط الزيوت الحديثة المنسربة للاسطح المائية وايضا لكشط الزيوت التي تآثرت بالعوامل الجوية بعد تركها فترات زمنية مختلفة على الاسطح المائية قبل الاستعادة لمحاكاة ما يحدث في الواقع. وجد ان التصميم الجديد المقترح لكشط الزيوت يعمل بحدلات مرتفعة في استعادة زيوت بلزوجات مختلفة وتم اختبار النموذج في وجود رياح بسرعات مختلفة وايضا امواج سطحية بارتفاعات موجية مختلفة.

ABSTRACT

In offshore oil spills a thin oil layer has to be skimmed off from the sea surface. A mechanism for cleanup of oil spill from water surface was developed using a ribbed-grooved rotating disc. The effect of various compound surface configurations of the two opposite walls of the considered ribbed-grooved disc on the oil recovery performance was investigated for various disc rotational speed. Tests have been carried out for recovering fresh oil spill as well as weathered oil spill. Generally this clean up operation has to be carried out in sea water with different conditions, so the oil recovery performance of the considered rotating ribbed-grooved discs was studied for calm water surface and also in the presence of various wind speeds and water surface waves. The results show that the oil recovery performance of the ribbed-grooved disc is the highest in comparison to the other considered rotating discs. The ribs and grooves on the opposite walls of the rotating disc enhances the oil recovery rate by 2-2.5 times of the original flat rotating disc. The results also emphasized that a good oil recovery rate can be achieved even in rough meteorological conditions.

1. INTRODUCTION

Petroleum hydrocarbons enter marine environments in a variety of ways including natural ones, offshore production, marine transportation, atmosphere, and land-based ones. This have increased the risk of oil pollution of seawater and coastal areas. Just less than half of all marine oil pollution is associated with transportation activities. Glourlay [1] stated that there had been 186 tanker accidents involving 1360 tons or more of oil spilled between 1970 and 1985. Since 1987, there has been an increasing trend in tanker accidents with about 178,000 tones of oil spilled in 1988. So, global oil pollution is expected to be a problem for the next several decades. When oils are spilled on the sea their physical and chemical properties change rapidly due to weathering. The changes in physical properties of oil will influence the behavior and the recovery of the oil spills. The rate and extent of the changes in chemical and physical properties of the spilled oil caused by weathering will depend on the chemical composition of the oil and prevailing conditions such as temperature, wind speed and sea state [2].

Levine [3], stated that consideration must be given to both short and long term adversely impacts from the selected oil recovery technique. to ensure that the oil spill recovery effort does not do more damage than the oil spill itself. He also reported that the oil spill location, time of year, weather, size of spill highly affected the oil recovery operation. In assessing the efficiency of various oil spill removing options, two factors must considered: encounter rate and effectiveness.

In-site burning is one of the developing technique for rapid removal of large quantities of spilled oil at sea and in ice infested waters. Recent work has demonstrated the feasibility of these applications of in-site burning [4]. Through experiments carried out in recent years, it became clear that burning of a crude oil spill requires a large spill thickness, other factors affect the success of this technique including the properties of the oil at the time of ignition and meteorological conditions. However, igniting the oil spills contributes to the increase in greenhouse gases causing another environmental damage such as air pollution and acidic rains [5].

The use of chemical dispersants to clean up the oil spills in many environments is controversial. A dispersant response aims to take the oil spill off the sea surface into the water column in the form of small droplets, less than 70 μm in diameter, [6]. In addition, natural biodegradation of the oil droplets in the water column will take place over time. This fact has the disadvantage that oil spill thickness will be relatively small, so large amounts of dispersants are required during the dispersant spray operation. Chemical dispersants have been used to increase the surface area of the oil spill to attempt to speed oil degradation. However, the toxic properties of dispersants as well as the oil that is dispersed in the water column may simultaneously inhibit degradation activity. So, dispersants use to remove the floating oil spill from the water surface as quickly as possible and then dump it into the water column with a great risk of toxicity which can cause more environmental damage especially to sensitive areas near the coastline.

Alternatively, mechanical technique of removing oil spills generally shows reasonable encounter oil recovery rates and effectiveness without any damage or harmful consequences to the fresh or sea water environment in short or long term. Also with the mechanical technique oil spills can be recovered and reused again. Few studies have shown that vortex skimmers can be employed to recover oil spills, by means of creating a vortex in the center of a collection chamber where the oil gathers and can be pumped away. However, the oil recovery efficiency is fairly low [7]. Vortex skimmers oil recovery efficiency nearly diminishes in the presence of currents and waves as proved by [8].

To fulfill this task, a systematic oil spill recovery program in which fluid mechanics is employed was carried out by the author. Recently, a new and improved design of an oil spill recovery model with a floating weir equipped with a rotating cylinder was investigated in a calm water surface, [9]. The new design oil recovery operation and capabilities of removing the oil spill from the water surface with increasing efficiency was significantly enhanced by the use of a floating weir with a rotating cylinder. El-Minshawy [10], has suggested a waves damper for damping and

dissipating the waves action in front of an oil spill recovery system. The investigation highlighted the importance and the great need for waves damper to be placed in front of the oil recovery model to damp the wave height during the oil recovery operation to achieve a good oil recovery performance. In a recent investigation, reported in [11], an oil spill recovery system with a rotating corrugated disc has been developed. The findings of this investigation indicated that the corrugation superimposed on the rotating disc surface improves the oil recovery rate for both fresh and weathered oil spills.

The aim of the present work is to evaluate the oil recovery performance of the rotating ribbed-grooved disc in a calm or rough meteorological sea conditions. For, this purpose, five models of rotating disc skimmers were made with different geometry and with a combination of ribs and grooves. The effect of varying the disc rotational speed, oil viscosity and oil spill initial thickness, wind speed and water surface wave height on the performance of the considered ribbed-grooved rotating disc have been investigated. The oil spill recovery performance of the already existed original flat rotating disc for similar dimensions and test conditions as the ribbed-grooved disc was also measured for comparison.

2. EXPERIMENTAL APPARATUS

To improve response technology to oil pollution, a standardized laboratory procedure is needed to generate representative spill of fresh oil and weathered oil to evaluate the performance of the considered ribbed-grooved rotating disc as oil removing technique. To simulate the recovery of the oil spill from the water surface in the sea filed, a water channel was built especially for that purpose. The apparatus used in the experiments is shown schematically in Fig. 1. The water channel used in the experiments is an elliptic circuit track type, which has a rectangular cross section of 0.8 m×0.6 m and overall length of about 10 m. The water depth in the channel was 0.6 m. To simulate the various types of wind driven action, air flow was supplied

tangentially to the free water surface by an air blower fixed at the upper end of the water channel. The air blower capable of delivering up to $0.125 \text{ m}^3/\text{s}$ of air with a maximum air velocity of 20 knots ($\text{knot}=0.514 \text{ m/s}$) above the water free surface. The water channel is also equipped with an electrically driven flap-type wave generator, fixed at one side of the channel, capable of generating surface wave patterns. The wave generator consists of a variable speed flap which is driven by an electric motor through an arrangement of an eccentric disc. To obtain a wave action with different heights, the eccentric disc is provided with a sliding pin that can move through the radial direction. So by changing the radial position of this pin, various flap speeds can be obtained and consequently wave heights in the range of 5 cm to 20 cm were generated in front of the considered oil recovery system. The front side wall of the water channel accommodates at its middle section with a glazing window to ease direct visual observation study and to measure the waves heights with the aid of vertical scale tap during the tests.

As the experimental technique rely on adhesion of the spreading oil spill on the water surface to the solid surface of the rotating disc during the upward rotation, the objective of this study is to investigate the effect of compound ribs and grooves on the rotating disc on the oil spill recovery rates. Five different models of discs machined with various arrangement of surface ribs and grooves were tested in the present work. The discs were made from aluminum with 50 cm diameter and 1.5 cm thick. In this study, the ribs and grooves shape is nearly machined as trapezoidal. Two of the models (1) and (2) are machined with 4 ribs and 4 grooves on each surface of the disc. However, both discs have different rib pitch (or groove pitch) to rib height (or groove depth) ratio (p/e) and pitch to rib width (or groove width) ratio (p/t). For the first disc model (p/e) and (p/t) are 14.3 and 7.1 respectively, and the second disc model has (p/e) = 20 and (p/t) = 10. Third model surface is provided by 8 ribs only with (p/e) = 20 and (p/t) = 10. The fourth model is enhanced by 8 grooves only with (p/e) and (p/t) equal to 20 and 10 respectively. Finally, the fifth already existing rotating flat disc with the same disc diameter is considered for comparison. Table 1 lists the dimensions and

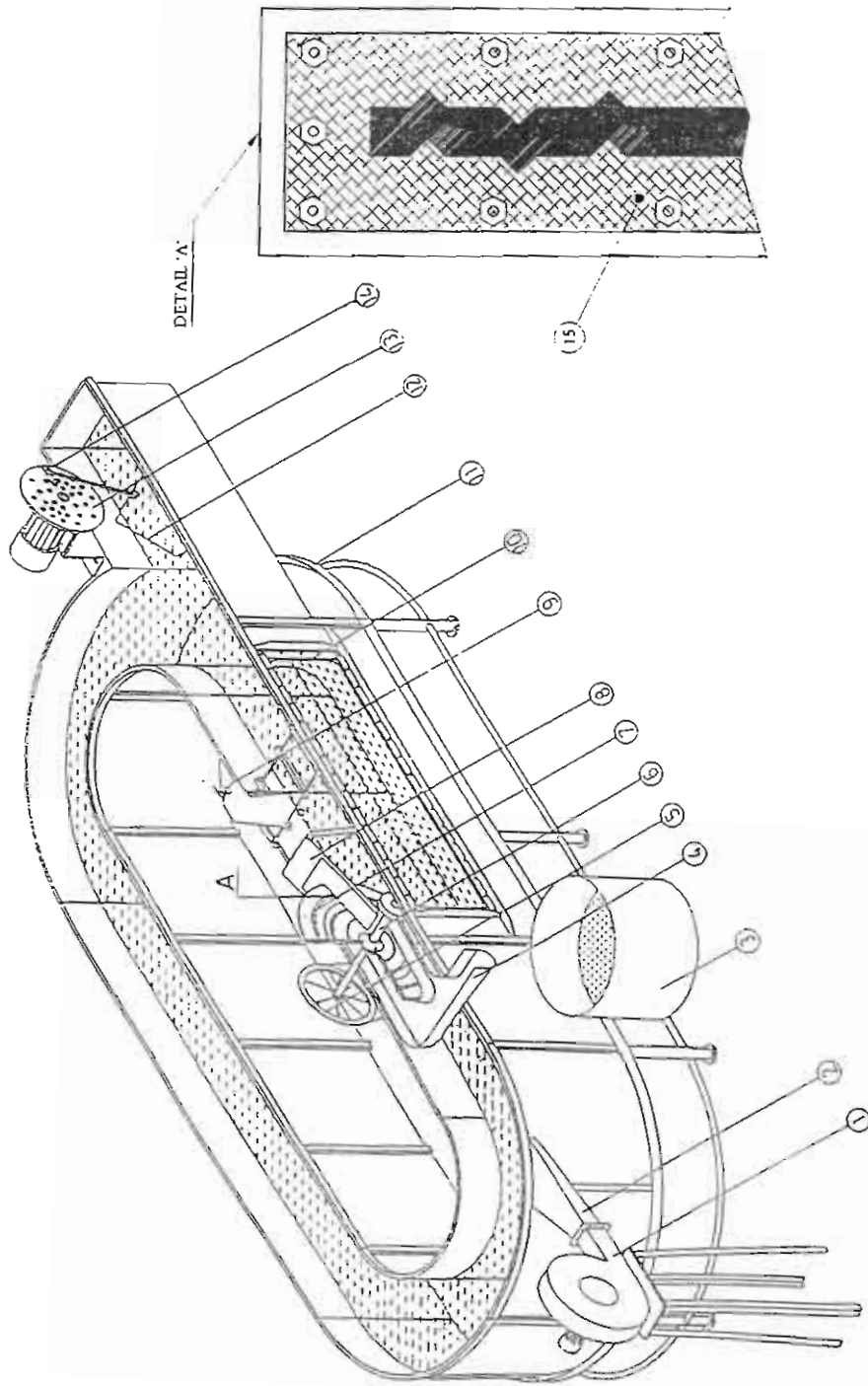

Fig. 1 Experimental apparatus, 1- air blower, 2- air conduit, 3- graduated vessel, 4- collecting channel, 5- pulley, 6- horizontal rotating shaft, 7- ribbed-grooved disc, 8- oil scraper, 9- wave height meter, 10- glazing window, 11- water channel carrier, 12- flap-type wave generator, 13- eccentric disc, 14- sliding pin, 15- scraper blades..

aspect ratio of all the disc models studied. Figure 2(a), 2(b), 2(c) and 2(d) show the schematic of the cross section of all the investigated discs. The disc to be used was mounted by four bolts between two flanges which are welded to a rotating shaft mounted horizontally

Table 1 Geometrical models dimension and aspect ratio for each rotating disc

Model No.	Surface Conditions	Diameter, mm	p/e	p/t	n_r	n_g
1	Ribs-Grooves	500	14.3	7.1	8	8
2	Ribs-Grooves	500	20	10	8	8
3	Ribs only	500	20	10	8	-
4	Grooves only	500	20	10	-	8
5	Flat Surface	500	-	-	-	-

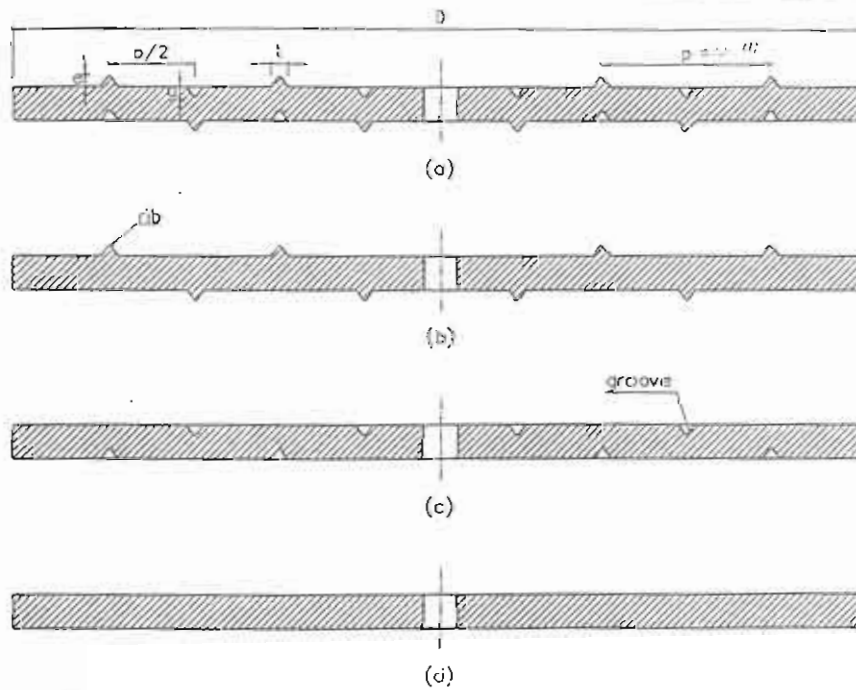

Fig. 2 Schematic of the cross section of : (a) ribbed-grooved disc, (b) ribbed disc, (c) grooved disc and (d) Flat disc

on two ball bearings. The disc is driven by a 1.5 KW variable speed electric motor, which is provided by a CDS inverter speed controller with a full digital control. The position of motor was arranged to transmit the motion to the horizontal rotating shaft and consequently to the disc through two pulleys and V-belt. The disc rotational speed was measured by a digital speedometer which gives the revolution per minute directly. As the considered discs are rotated in the vertical plane through the oil water interface, the oil adheres to the surfaces and is then removed using two scraper blades. The scraper blades which have exactly the same shape as the disc outer surface, (see details A) in Fig. 1, are fitted firmly in each side of the rotating disc. This scraper blade arrangement enables the adhering oil to be removed completely from the whole surface of the disc. Recovered oil was then drain down to the collecting channel from which it flows into an oil graduated vessel for the oil recovery rate measurement.

3. RESULTS AN DISCUSSION

3.1. The Effect of the Rotating Disc Geometrical Surface Configuration

Figure (3) shows the fresh oil recovery rates (Q_{or}) for the five investigated rotating disc models, ribbed-grooved surface with ($p/e=14.3$, $p/t=7.1$), ribbed-grooved surface with ($p/e=20$, $p/t=10$), ribbed surface only with ($p/e=20$, $p/t=10$), grooved surface only with ($p/e=20$, $p/t=10$) and rotating flat disc over a range of disc rotational speeds. A fresh oil spill with viscosity of 210 cSt is employed. The results indicate that the oil recovery rate enhancement for the ribbed-grooved rotating disc is higher than that for the ribbed or grooved rotating disc at similar (p/e) and (p/t). The oil recovery rate increases with an increase of the ribs or grooves height as well as their width. The ribbed-grooved rotating disc with ($p/e=14.3$, $p/t=7.1$) (model 1) provides the highest oil recovery rates augmentation. The ribbed-grooved disc with ($p/e=14.3$, $p/t=7.1$) provides 2-2.5 times the oil recovery rates of the already existing rotating flat disc at similar disc diameter. This seems to be due to that viscous drag of the oil adheres to

the disc against the gravity as well as the disc effective area for the ribbed-grooved wall is higher than those of the only ribbed or grooved wall and subsequently higher than the flat wall.

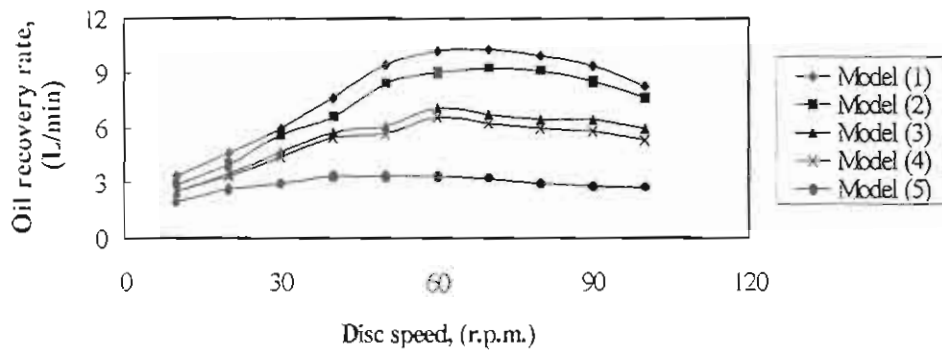

Fig. 3 Variation of fresh oil spill recovery rate at different disc rotational speed for the five models presented in table 1.

3.2 The Effect of Fresh Oil Spill Viscosity on the Ribbed-Grooved Disc

Performance:

The variation in the fresh oil recovery rate for different oil viscosity is shown in Fig. (4). Tests has been performed using the rotating ribbed-grooved disc model (1), with ($p/e=14.3$, $p/r=7.1$). In this figure fresh oil spill with zero elapsed time was employed, oil which immediately recovered after being placed on the water surface.

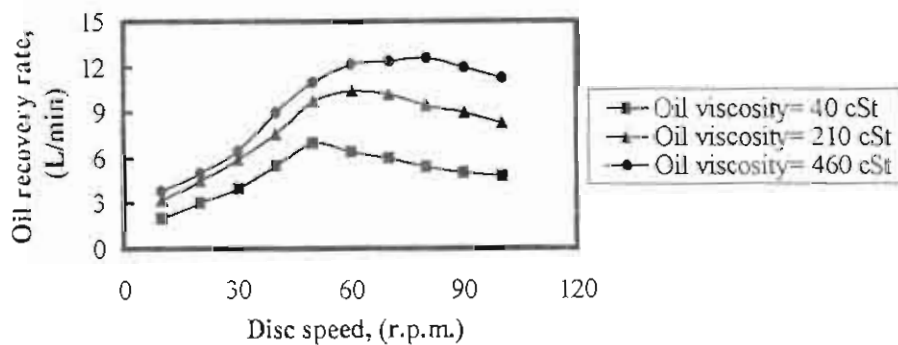

Fig. 4. The effect of fresh oil spill viscosity on the oil recovery rate at different disc rotational speed.

Tests been carried out at different disc rotational speeds. These curves indicate that the oil recovery rate increases by increasing the fresh oil viscosity. Also oil recovery rate increases by increasing the disc rotational speed. It can also be seen that the optimum oil recovery rate for the light oil viscosity (40 cSt) is at about 50 r.p.m., this optimum peak occurs at a higher rotational speed as the oil viscosity increases. One fact is obvious, the more the viscous the oil, the slowly the fresh oil spreading resulting in a thicker final stabilized oil spill thickness and so highly improve the oil recovery rate. This is beside, fresh oil with high viscosity adheres readily to the solid surface of the disc during the upward rotation through the oil-water interface.

3.3 The Effect of Weathered Oil Spill Elapsed Time on the Ribbed-Grooved Disc Performance :

This section describes and discusses the experimental results of the weathered oil spills recovery from the water surface using the considered ribbed-grooved rotating disc. In order to obtain weathered oil characterization, oil layers were placed on the water free surface for different period of time in ambient air temperature in the laboratory. Weathering would occur as the continuation of oil spill exposure to the atmosphere in the presence of sea water and other meteorological factors. Figure (5) shows the subsequent degrees of the rate of weathered oil recovery as a function of the elapsed time after the oil being placed on water surface. The curves illustrate that the weathered oil recovery rate increases at first by increasing the elapsed time with oil

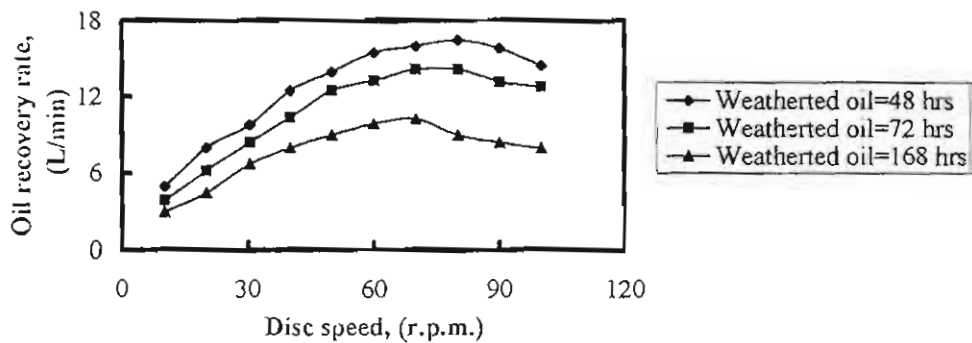

Fig. 5 Variation of recovery rate for weathered oil at various elapsed time.

being kept on the water surface for up to 48 hours until the maximum value of the oil recovery rate is reached. Then increasing the elapsed time causes a decrease in the oil recovery rate. The curves also indicate that for this particular weathered oil, still a higher recovery rates can be obtained in comparison to those results of the original fresh oil spill.

The reasons for that behavior of the weathered oil recovery results can be explained as follow:

As the oil spreads over the water surface, it is exposed to the ambient meteorological conditions and rapidly evaporates during the initial period of weathering as confirmed in refs. [12]. This evaporation loss was reported to be about 25 % in 24 hours [13] and reached about 30-35 % in 48 hours [12]. This evaporation loss is associated with a complete loss of the volatile light components in the oil which have a low molecular weight. The oil recovery rate increases for the weathered oil in the early 48 hours. Consequently and as a result of the early rapid evaporation, the viscosity of the oil spill gradually increases during the same period of elapsed time. These remarkable increases in the weathered oil viscosity cause the adhesion between the oil spill and the rotating ribbed-grooved disc to be highly increased and consequently increasing the oil recovery rate during the early 48 hours of elapsed time. The rapid oil evaporation is followed by a gradual increases of the water content absorbed sharply in the remaining oil as the elapsed time increases and these are laboratory confirmed and in the sea field experiments, refs. [14, 15]. Due to the increase of the water content in the spilled oil, the specific gravity of the remaining oil increases as elapses time increases and so the oil recovery rate decreases and the water recovered with the recovered oil increases.

3.4 The Effect of Oil Spill Thickness on the Ribbed-Grooved Disc Performance

Figure (6) shows the variation of fresh oil spill recovery rate for the first model of ribbed -grooved rotating disc in the present investigation at different oil spill initial thickness compared with Elminshawy's data [11] for the corrugated rotating disc with

similar disc diameter. The disc rotational speed was kept fixed at 60 r.p.m. and fresh oil spill with 210 cSt viscosity was employed. The figure implies that the current ribbed-grooved disc is clearly the best in oil recovery rate compared with those results of the original flat disc as well as the corrugated disc, considering the same disc diameter and rotating speed. The figure indicates that the oil recovery rate when ribbed-grooved model is used is higher, by as much as 2.3-3.4 times and 2.8-3.8 times those results of oil recovery rates of the corrugated and flat rotating disc respectively.

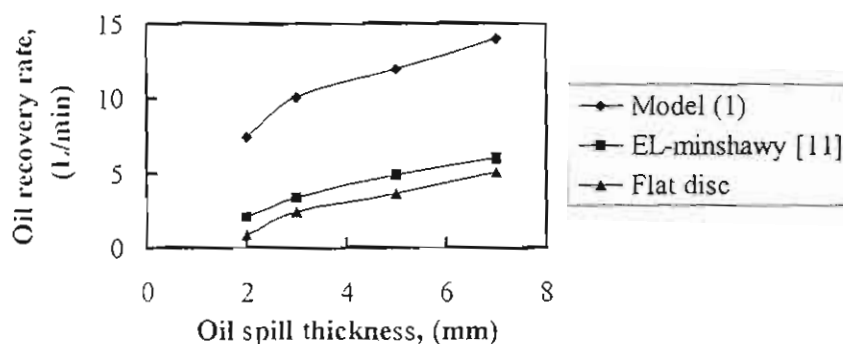

Fig. 6 The effect of oil spill thickness on the fresh oil spill recovery rate.

3.5 The Effect of Wind on the Ribbed-Grooved Rotating Disc Performance

In considering the behavior of the considered disc skimmer under the full range of sea conditions that might be encountered during the oil spill recovery, the most important parameter is the wind action (direction and speed). In open sea, the waves action is also important and will be considered in the next section. In the present work, counter current winds are considered as it is known that counter current winds tends to carry oil towards the oil recovery system and to increase the oil spill thickness. Figure (7) gives the oil recovery rate for four wind speeds as well as calm air using fresh oil spill. Fresh oil spill is employed in this set of tests with oil viscosity 210 cSt. Tests were carried out at various wind speed namely, 0 knots (calm air), 3-10 knots (gentle to moderate) and finally 20 knots (strong). These curves indicate that the oil recovery

rate increases by increasing the wind speed till wind speed = 10 knots. However, at strong wind speed 20 knots, the oil recovery rate markedly decreases.

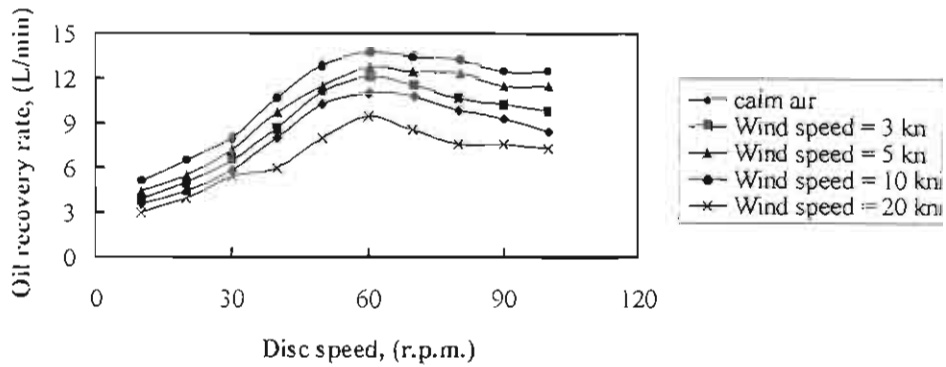

Fig. 7 The effect of wind speed on fresh oil spill recovery rate.

Figure (8) shows how the oil recovery rate vary as a function of ribbed-grooved disc rotational speed for weathered oil spill at different wind speeds ranging from 0-20 knots. Weathered oil spill with 72 hours elapsed time was used in this tests. Unlike the previous figure, the obtained data revealed that for this particular type of weathered oil spill, the recovery rate increases continuously with the increase of the wind speed for all the range of the studied wind speeds.

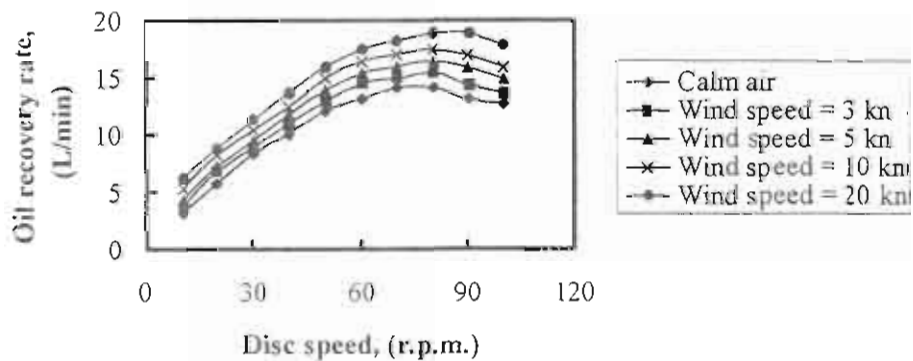

Fig. 8 The effect of wind speed on weathered oil recovery

The explanation for the above behavior of both fresh and weathered oil spill recovery in the presence of wind action can be put as follow:

Wind blowing over the water exerts frictional forces on its surface, and this friction which tends to retard the wind near the water surface. In the presence of oil spill on the top of water surface, this wind sets the oil spill in motion primarily in the same direction as the wind. Clarke [16], stated that, oil spill at the top of water surface moves at speed of about 3-4 % of the surface wind speed. In considering the behavior of fresh oil spill and weathered oil spill during the wind action tests, visualisation study were made, the finding were plotted in Fig. (9). From this study, at relatively low and moderate value of wind speed, the general shape of the oil spill becomes dynamic. An illustration of these features is the initiation of a surging mechanism that propagates from the upstream region of the spill and pulses in a downstream direction towards the oil recovery system area. As this surge moves towards the disc skimmer, the oil spill thickness increases as its length reduces. So, oil spill can accumulate to a large thickness in a coherent layer prior to the disc. The reverse pattern appears when the wind speed increase to 20 knots for fresh oil recovery as the fresh oil spill starts to reflect off the skimmer and travels upstream in a disorder shape. The intensity of the surging and behavior of oil spill in response to the wind action appear to depend on the

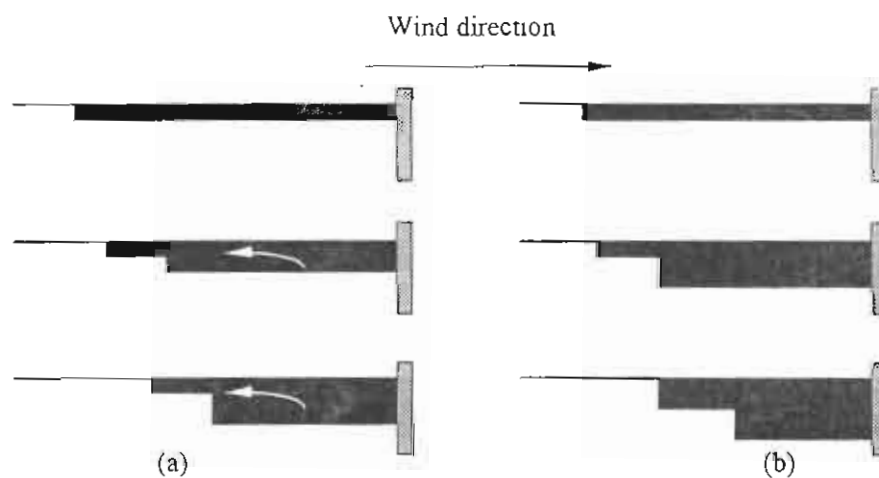

Fig. 9 Typical initial oil spill behavior during the wind action (a) fresh oil spill, (b) weathered oil spill

wind speed and the oil viscosity. At wind speed 20 knots and unlike the fresh oil spill recovery at that case, and due to its high viscosity and the retaining of it is consistency, the weathered oil spill tends to keep moving towards the disc system without recirculation backward, and still high oil recovery rate can be obtained at strong wind speed.

3.6 The Effect of Water Surface Waves on the Ribbed-Grooved Rotating Disc Performance

Figure (10) shows the variation of fresh as well as weathered oil spill recovery rate for different surface wave height to depth of water in the channel using ribbed-grooved rotating disc with ($p/e=14.3$, $p/t=7.1$). The disc rotational speed is kept constant at 60 r.p.m. The results show, as expected, that the oil recovery rate decreases with increasing the surface wave height to the depth of water. The figure also illustrates that the recovery rates are higher for weathered oil recovery than those for fresh oil recovery. Oil spill was skimmed off from the water surface successfully at low water surface wave height, however, large wave height results in difficulties as waves contract and reflect which causes the fresh oil spill to break and in this case it is impossible.

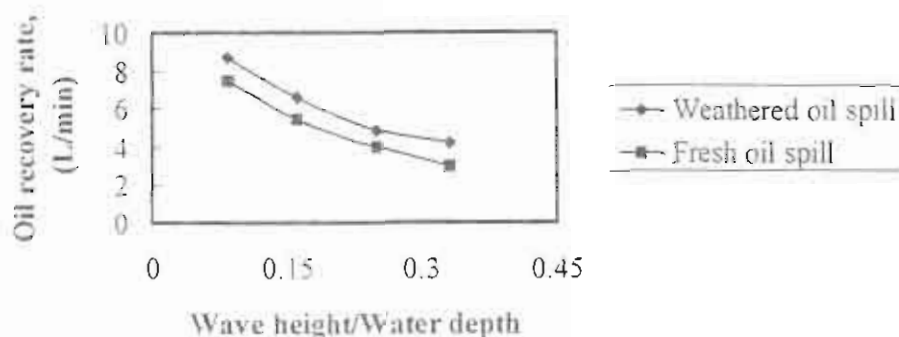

Fig. 10 The effect of wave height on fresh (or weathered) oil spill recovery rate.

however, to recover pure oil only. Furthermore, weathered oil which is relatively higher in viscosity spreads slowly over the water surface and still retaining a high thickness during the recovery operation even with the presence of waves action and so still a good oil recovery rate can be obtained.

The variation of oil recovery rate experimental results are condensed and summarized by fitting it to a correlation for each type of oil, the following two correlations describe the oil recovery rate for both fresh and weathered oil in terms of all the studied parameters, disc rotational speed, fresh oil viscosity, oil spill initial thickness, wind speed and wave height. The best correlations which predict the oil recovery rate are as follow:

For fresh oil recovery:

$$Q_{or} = 0.322 \{N^{0.234} \ln(v^{0.545}) S^{0.091} \text{Exp}(w^{0.11})\} / \{\text{Exp}(k^{0.475})\} \quad (1)$$

For weahered oil recovery:

$$Q_{or} = 4.561 \{N^{0.439} w^{0.168}\} / \{\ln(T^{0.577}) \text{Exp}(k^{0.837})\} \quad (2)$$

To confirm both correlations, a comparison between the experimentally measured results and the analytically predicted oil recovery rate is plotted in Fig. (11) for fresh oil recovery and in Fig. (12) for weathered oil recovery. This comparison shows a moderately validation for both correlations within $\pm 15\%$ error from the measured values.

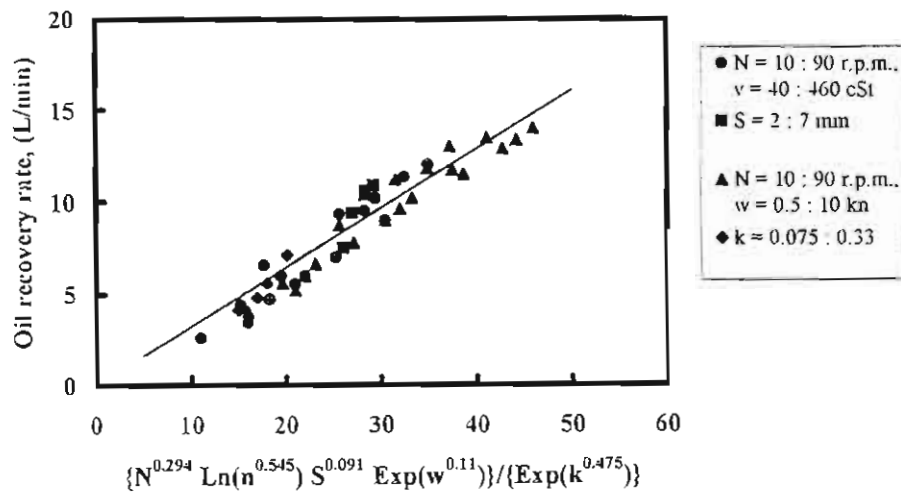

Fig. 11 Correlation for fresh oil recovery.

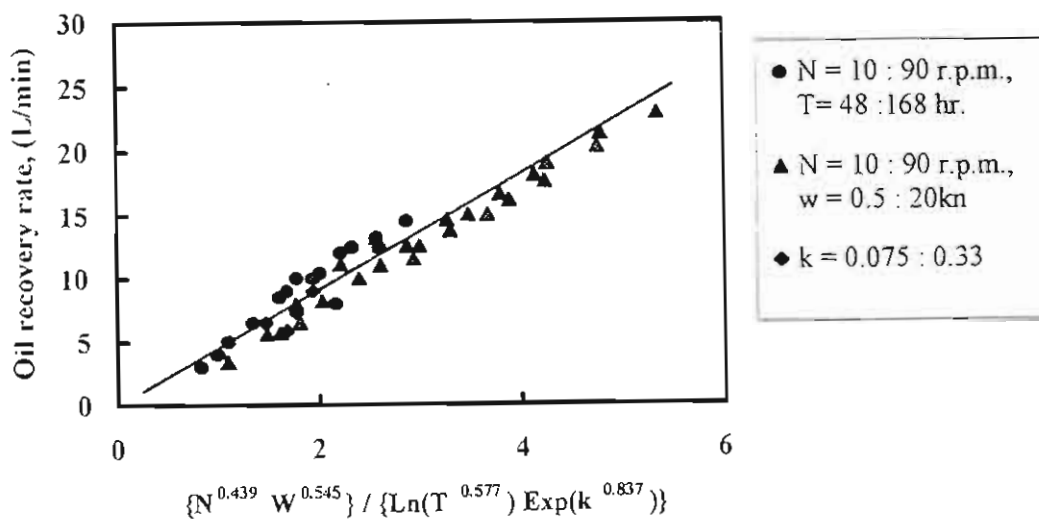

Fig. 12 Correlation for weathered oil recovery.

4. CONCLUSIONS

The outcomes of the experimental results suggests the following conclusions:

1. The oil recovery rate values using ribbed-grooved rotating disc are higher than those of rotating disc with ribs or grooves only. The ribbed-grooved rotating disc with ($p/e=14.3$, $p/t= 7.1$) provides the highest oil recovery augmentation compared to other studied models.
2. Results of the tests trials were very encouraging, in one typical example, 50 cm ribbed-grooved rotating disc skimmer resulted in an average recovery of 10 l/min. of oil from a water surface area of 2.7 m². This amount could easily have been increased, perhaps by using a multiple ribbed-grooved rotating discs.
3. For similar rotating disc diameter, the ribbed-grooved disc enhances the oil recovery rate by about 2-2.5 times the values of the already existed classical flat rotating disc.
4. It is noteworthy that the research and development represented by this work indicate that the ribbed-grooved disc skimmer mechanism is practical for removing significant amounts of realized oil spill without waste disposal.
5. The optimum performance of the ribbed-grooved disc skimmer is related to the properties of the oil being spilled, and particularly to its viscosity. Other factors affecting the performance of the disc skimmer include the elapsed time through which the fresh oil has converted to weathered oil.
6. Ribbed-grooved rotating disc operates effectively in the presence of low and moderate wind speed and oil recovery rate increases with the increasing of wind speed for both fresh and weathered oil. A continuous increase of the oil recovery rate is obtained also in the presence of strong wind for weathered oil recovery, however the fresh oil spill recirculates and reflects off the skimming area in the presence of strong wind and so the recovery rate is reduced.

7. Oil spill was recovered from the wavy water surface successfully at moderate surface waves, large waves results in breaking the oil spill and in this case it is impossible to recover pure oil only.
8. To facilitate the use of the results in future studies as well as in practical applications, two empirical correlations have been developed for both fresh and weathered oil recovery as a function of all the studied parameters.

ACKNOWLEDGMENTS

The author is most grateful to Prof. Dr. Monier Helal, Mech. Power Eng. Dept., Cairo University for his great advice.

REFERENCES

1. Gourlay, K.A. "The black death: Oil in: poisoners of the seas" Zed Books Ltd., London, pp83-118, 1988.
2. Daling, P.S., Brandvik, P.J., Mackay, D. and Johansen, O. "Characterisation of crude oils for environmental purposes" Proceedings of the 13th Arctic and Marine Oil Spill Program, Canada Ottawa, Ontario, 1990.
3. Levine, R. A. "Contingency planning for oil spills: an update based on experience gained from the Port Angeles spill" Marine technology, Vol. 25, No. 2, April 1988. pp. 145-159.
4. Allen, A.A. and Ferek, R.J. "Advantages and disadvantages of burning spilled oil" Proceeding of the International Oil Spill Conference, Washington, D.C., pp. 765-772, 1993.
5. Evans, D.D., Walton, W.D., Baum, H.R., Notarianni, K.A., Lawson, J.R., Tang, H.C., Keydel, K.R., Rehn, R.G., Madrzykowski, D., Zile, R.H., and Tennyson, F.I. "In-situ burning of oil spills" Proceedings of the Fifth Arctic and Marine Oil Spill Program, Canada, Ottawa, Ontario, 1992.
6. Lunel, T. "Dispersion: Oil drop size measurements at sea" Proceedings of the 16th Arctic and Marine Oil Spill Program, Canada, Ottawa, Ontario, 1993.
7. Urban, R.W., and Graham, D.J. "Performance tests of four selected oil spill skimmers" EPA-600/2-78, U.S.A. Environmental protection agency, Cincinnati, Oh., 1978.
8. Solsberg, L.B. "A catalog of oil skimmers" Environmental protection service, Ottawa, Ontario, 1983.
9. El-minshawy, N.A. and El-sawaf, I.A. "New design of an oil recovery model with a floating weir equipped with a rotating cylinder" Al-Azhar Engineering Third International Conference, Dec., 1993.
10. El-minshawy, N.A. "An oil spill recovery from a wavy water surface" Ain-Shams University, Faculty of Engineering Scientific Bulletin, Vol. 29, Part 3, 1994.

11. El-minshawy, N.A. " Experimental investigation on an oil spill recovery from water surface using rotating corrugated discs " ASME Inernational Congress on Fluid Dynamics & Propulsion, Organised by The ASME and Cairo University, Dec., 1996.
12. Stiver, W. and Mackay, D. " Evaporation rates of spills hydrocarbons and petroleum mixtures " Environmental Science and Technology, V 18, pp. 834-840, 1984.
13. Smith, W. " The control of oil pollution on the sea and inland water ", Graham & Trotman Ltd., pp. 32-33, 1976.
14. Daling, P.S., and Brandvik, P.J. " Tools for assessing the weathering processes of oil spills at sea and the effectiveness of oil spill dispersants " Proceedings of CONCAWE/DGMK Scientific Seminar, Remediation of oil spills, pp. 103-116, 1992.
15. Walker, M., McDonagh, M. and Albone, D. " Comparison of observed and predicted changes to oil after spill " Proceedings of International oil spill Conference, pp 389-393, 1995.
16. Clarke, R.B. " Marine pollution " Clarendon Press, Oxford, 1997.

NOMENCLATURE

D = disc diameter, (mm)

H = surface wave height, (mm)

N = disc rotational speed, (r.p.m)

Q_{or} = oil recovery rate in a certain period of time, (liters/s)

S = oil spill initial thickness, (mm)

ν = fresh oil spill kinematic viscosity, (m^2/s)

p = rib or groove pitch, (mm)

t = rib or groove width, (mm)

e = rib height, (mm)

g = groove depth, (mm)

n_r = number of ribs

n_g = number of grooves

p/e = rib pitch (or groove pitch) to rib height (or groove depth) ratio

p/t = rib pitch (or groove pitch) to rib (or groove width) ratio