

# Online Stability Analysis during Power System Restoration Based on Phasor Measurement Units

## تحليل حاسوبي مباشر عبر الإنترنت لعملية إستقرار منظومة القوى الكهربيه أثناء عملية الإسترجاع إعتماًداً على وحدات قياس الطور

M.F. Kotb, S.S. Kaddah, K.M. Shebl and M.T. Elsedek

Electrical Engineering Department, Mansoura University, Mansoura 35516, Egypt

### المخلص

يقدم البحث دراسة لإستقرار منظومة القوى الكهربيه أثناء عملية الإسترجاع بإستخدام نظام المراقبة عن بعد عبر الانترنت **WAMS** وذلك لضمان عملية إسترجاع سهلة ومميزة. ويعتبر من أهم الإضافات التي يقدمها البحث هو مساعدة المشغل بإتخاذ القرارات المناسبة والحيوية بشأن خطوات التحميل أثناء تحميل المولدات خلال عملية الإسترجاع لضمان إستقرار المنظومة الكهربيه. وقد تم التقدير الدقيق لكافة متغيرات نماذج المولدات والاحمال بإستخدام **WAMS**. ويعتبر من أبرز الإسهامات الأخرى في ذلك البحث هو تقديم مقترح لترتيب توصيل خطوط الربط الهامة التي يجب توصيلها بين الجزر المختلفة لإستعادة النظام بالكامل إعتماًدا على توحيد زوايا الطور داخل الجزر المختلفة إلى مرجع وحيد بإستخدام **WAMS**. وقد تم استخدام طريقة البناء بالتقسيم لإسترجاع منظومة القوى الكهربيه بالكامل. كما أدى تواجد نظام المراقبة عن بعد **WAMS** بإستخدام وحدات قياس الطور **PMUs** إلى تبسيط عملية الاسترجاع عن طريق مساعدة المشغل بإمكانية قياس زوايا الطور المتزامنة لكافة متغيرات المنظومة الكهربيه. وقد تم استخدام برنامج **Dig SILENT** لدراسة عملية إستقرار المنظومة الكهربيه خلال مراحل الاسترجاع المختلفة. وقد تم استخدام نظام **The New England 39-bus power test system** كنموذج لمنظومة كهربيه كبيره كى يتم التحقق من المقترح المقدم والتأكد من نتائجه وقابلية تطبيقه فى الأنظمة العملية.

### Abstract

This paper presents a study for electrical power system stability during restoration operation utilizing Wide Area Measurement System (WAMS) by using Phasor Measurement Units (PMUs) to guarantee smooth power system operation. One of the major benefits of this research is to provide the operator with the critical decisions about generators loading steps at the restoration process ensuring power system stability. Generators and Loads models parameters are accurately estimated using WAMS data. Another important benefit is suggesting priority list of the most feasible tie lines that can be closed between different islands needed to be integrated during restoration depending on the unification of islands phase angle references using WAMS. The buildup restoration strategy is used to restore the Bulk Power System (BPS). Nowadays, the introduction of WAMS using PMUs facilitates the restoration process by allowing the operators to access the phase angle of all power system quantities synchronously. Dig SILENT software is used to study the stability during the early restoration stages. The New England 39-bus power system is used as a large-scale power system to demonstrate the proposed algorithm, verify the results and prove its capability in practical systems.

### Keywords

Blackout, Power system restoration, Build Up strategy, Wide Area Measurement System (WAMS), Phasor Measurement Units (PMUs), Transient Stability.

### I. Introduction

Despite all the efforts towards minimizing interruptions in the power supply due to power system failures, the power system is still subjected to great outages [1]. The problem of restoring power system

elements after major outage is nearly as old as the power industry itself and it is technically complex, time-consuming, likely to fail and repeat system outage [2]. In the meantime, damages to the customers and to the industry increased rapidly, so extension of the

restoration process imposes many economic and political costs to the system, so making this process faster as well as effective and secure is very important task [3]. Due to the importance of restoration process, two well-known strategies to restore a power system are developed [4-7]. One of them involves reenergizing the network before resynchronizing generators which is called the *build-down* strategy. The other strategy involves sectionalization of the power system into some islands, restoration of each island, and then synchronization of the islands by interconnecting them which is called the *build-up* strategy.

Smart grid technologies are expected to enable a grid to be restored from major outages efficiently and safely [8-13]. In the meantime, the improvement of synchronized measurements and communication speed and accuracy facilitates monitoring, controlling and operation of large power systems in wide areas. WAMS enable operators and researchers to measure and define power system quantities synchronously in more detailed time scale and analyze the power system with new techniques [10-13]. PMUs measure power system variables synchronously depending on the available time reference through Global Positioning System (GPS) satellite clock [8-9]. One of the major benefits of WAMS is the evaluation of the network-wide reference phase angle, based on which the phase angle of all the power system variables can be assessed. By utilizing synchronous measurements during the restoration process, the operators can monitor the voltage angle across every line. Using WAMS enable differentiation between the lines and close the circuit breaker with very small phase angle difference [11].

The buildup strategy that is regarded as one of the powerful techniques for power system restoration planning is considered as the basis for this paper [7]. The third part in the buildup strategy is the process of restoring each separated, independent island. The

introduction of WAMS using PMUs measurements overcomes the problem of measuring power system quantities at different network locations synchronously [13]. This paper is going to study the power system stability issues during the restoration process of any power system. Power system is sectionalized into number of independent restorable islands that satisfy essential constraints for restoration process [14]. The optimal restoration path of each island is also identified. [15]. The final stage of the restoration process is decomposed into two stages, the process of building each subsystem and the process of interconnecting these subsystems to establish the Bulk Power System (BPS) [16-24].

During the first stage, the power system is organized as disconnected subsystems, namely islands. The critical decisions to be made at this stage are BSU start-up procedure, remote cracking of NBSUs, constructing the transmission network and load pickup [16-17]. The objective function at this stage is to maximize the restored load and minimize the restoration process duration in each island without violating constraints [18-24]. The utilization of WAMS provides the operator with exact estimation of load and generation models parameters. These models help the operator to take critical decision about loading steps. In fact, such an accurate estimation cannot be simply achieved without using WAMS [10-13].

Alternatively, the last stages of restoration are made up of the interconnection of the disconnected islands to establish the BPS. Power system is arranged as stable disconnected subsystems. The major objective at this stage is to identify the correct sequence of interconnecting the boundary lines (tie lines) between these islands without violating constraints [24]. Closing a tie line with big standing phase angles difference (SPA) among its buses shock the system and may disturb the whole restoration process and repeat the outage .The major complexity in

interconnection of these islands by using conventional methods is the difficulty of the unification of the phase angles at subsystems towards a unique reference in order to synchronize them. Here, the role of different PMUs at disconnected subsystems appears and by utilizing WAMS, the PMUs installed within a subsystem can measure/estimate their generator bus voltages and phase angles to a unique reference easily and faster. Hence, the stability is assessed at this stage and the tie lines energizing priority list can be identified.

This paper presents a new approach to monitor the stability online during power system restoration and deals with final stages of restoration. The importance of studying stability during restoration using WAMS is associated with the following issues:

- Investigation of the generator loading schedule to avoid increasing of the loading steps above the critical limits that will lead to power system transient instability.
- Evaluation of the energizing tie lines without phase angles unification because if any tie line is energized without reference phase angle unification at disconnected islands, it may result in a strong shock in power system stability.
- Prioritization of energizing tie lines after phase angle unification as improper prioritization of energizing tie lines may result in failure of the restoration process.

The New England 39-bus power system is chosen as simulation test systems in this research.

## II. Proposed approach

The main contribution of this paper is introducing two algorithms to study the stability problem during power system restoration utilizing WAMS. The first algorithm is used to build up stable subsystems during early stages of restoration depending on the utilization of WAMS. Electrical power generation, loading sequence, electrical frequency, oscillations of the rotor

angles of generators and the voltage at different buses of islands are monitored during building up these islands. The main objective at this stage is to maximize the restored loads and minimize the restoration time without violating any constraints. If any violation is detected, the proper action is taken to satisfy the violated constraint. The stability is assessed during this stage while synchronizing generators, picking up loads and energizing high voltage transmission lines. Based on the restoration timing table and the proposed loading step, the loading schedule of each island is identified and investigated. Dig SILENT software is used to study the stability during early restoration stages [25]. The second algorithm is used to identify the interconnection order of tie lines between subsystems during last stages of restoration depending on the utilization of WAMS. Unification of phase angle across disconnected subsystems using WAMS provides the operator with the phase angle difference across each tie line. The main objective at this stage is to connect the tie lines to establish the BPS without violating any constraints. Tie lines energizing priority list is established considering that the tie line with smaller phase angle difference is connected at first. The priority list is not updated after connection of tie lines due to smoother phase angle profiles after connecting each tie line. The power system dynamic response concluded the rotor angle oscillations of generators to this PBS establishment plan and the electrical frequency variations at generators during the process of frequency adaptation throughout the power system are monitored during interconnection process. Dig SILENT software is used to study the stability during last restoration stages

## III. Methodology

The stability problem can be classified as steady-state stability while the power system is gradually being built up, transient stability as initiated by likely faults or sudden changes in power system or instability because

of exceeding the minimum excitation levels (high voltages, large charging currents and ample reactive power). This paper considers the power system transient stability as well as the small signal stability assessment during restoration. Restoration actions such as generators start-up, energizing the transmission lines, increasing of the generation and loading and islands interconnection planning are done considering achieving the transient stability constraint. The following items describe the proposed approach for power system restoration.

- Building Up Stable Restoration process Using Utility Generators.
- Islands Interconnection.

### A. Building Up Stable Restoration Process Using Utility Generators

The main objective of power system restoration problem is achieving fast, effective, secure and reliable restoration process beside maximizing the restored load in the system and minimizing restoration process duration.

The buildup philosophy is selected for applying the proposed approaches. A systematic algorithm for sectionalizing a power system into islands is used considering various constraints such as assigning optimum number of PMUs, black-start capability of generators, and power supply-demand balance for each island which should be independent [14]. Matlab program based on Binary Integer Programming is created by utilizing WAMS to identify the minimal number of PMUs and its location that guarantee full observably islands.

The optimal restoration paths are identified in each island considering various restoration constraints such as ensuring the path observability, speed up the remote cranking of NBSUs, avoiding both transmission line thermal loading and over voltage [15].

At the early stages of restoration, BSU start-up procedure, remote cranking of NBSU

and load pickup are the critical decisions to be made. Thereupon, the electrical frequency and rotor angle oscillations besides the voltage magnitude analysis are exploited to assess the applicability of the restoration plan. This section presents an approach based on which the power system stability issues during the early stages of restoration are analyzed.

The following equations are combined together in such a way to describe the stability analysis during the process of building stable subsystems [26]. The equivalent single-generator system is utilized with the static load modeling to assess the stability after disturbances such as load pick up. Based on the classical representation of synchronous generators, the associate active power can be presented as follows:-

$$P_e = \frac{E V}{X} \sin(\delta) \quad (1)$$

Where  $V$  is the generator bus voltage and  $P_e$  is the generator active Power output,  $E$  is the generators' internal voltage,  $X$  is the reactance of the synchronous generator and  $\delta$  is the generator rotor phase angle.

Consider an N-generator system, when there is any generation-load imbalance, the motion of each generator rotor is given by the swing equation as:

$$\frac{2H d^2\delta}{\omega_s dt^2} = P_m - \frac{K_D d\delta}{\omega_s dt} - P_e. \quad (2)$$

where  $H$  is the rotor inertia constant,  $\omega_s$  is the synchronous speed,  $P_m$  is the mechanical power,  $P_e$  is the electrical power and  $K_D$  is the Damping constant.

If we model the N-generator system as an equivalent single-generator system, the swing equation in (2) would be

$$\frac{d\omega}{dt} = \frac{1}{2H_{system}} (P_m - P_e) \quad (3)$$

where

$$\begin{aligned} H_{system} &= \sum_{i=1}^N H_i \\ \& P_m &= \sum_{i=1}^N P_{m,i} \\ \& P_e &= P_{loss} + \sum_{i=1}^M P_{b,i} \end{aligned} \quad (4)$$

where  $N$  is the total number of generators,  $M$  is the total number of loads,  $H_i$  is the inertia constant of generator  $i$ ,  $H_{system}$  is the system inertia constant which is the sum of all generators' inertia constants,  $P_{m,i}$  is the mechanical power delivered to the shaft of generator  $i$ ,  $P_{b,i}$  is the load demand at bus  $i$ ,  $P_{loss}$  is the active power losses,  $\frac{d\omega}{dt}$  is the frequency dynamics following the addition of mechanical power of a generator or insertion of a load step and  $\omega$  is the system average angular frequency.

Arriving at a high level of detailed load modeling, static load modeling approach is utilized.

$$P_{l,i} = P_{0,i} \left( \frac{V_i}{V_{0,i}} \right)^{a_i} + b_i (\omega - \omega_s) \quad (5)$$

where  $V_{0,i}$  is the nominal voltage;  $P_{0,i}$  is the nominal load,  $\omega_s$  is the power system synchronous frequency and  $a_i, b_i$  is load model parameters.

The major steps to build stable subsystems are described based on aforementioned restoration timing table and generator loading steps as the following steps to identify the proposed algorithm to restore these islands:

**Step1:** Restart BSU for the island  $S$ .

**Step2:** Energize the busbar connected to BSU.

**Step3:** Energize the transformer connected to BSU.

**Step4:** According to the restoration timing

table, energize the next transmission line (TL) that connects the buses  $i$  and  $j$ .

**Step5:** Energize the busbar  $j$  at the end of the (TL).

- If there exists load center at busbar  $j$ , pick up the loads after preparing it according to the predetermined loading step.

- If there exists NBSU at busbar  $j$ , crank the NBSU then modify the loading step to match the available number of online generators.

**Step6:** Check the restoration constraints

- If any violation reported in frequency, take suitable action to balance the active power in order to maintain the frequency.

- Pick up more loads for over frequency or load shedding for under frequency.

- If any violation reported in voltage, take suitable action to balance reactive power to control buses voltage.

- Switch on series reactors and pick up lag PF loads for over voltage or switch on shunt capacitors besides adjusting generators reactive power and transformers taps for under voltage.

- If any violation reported in the transient stability, take suitable action to modify the loading steps in order to maintain system stability as the loading steps is proportional to the number of online generators.

- Decrease / Increase loading steps based on the available online generators to keep the stability within margins.

**Step7:** Coordinate between generators and loads by raising generators output and pick up more loads taking into consideration the proposed restoration constraints.

**Step8:** If all transmission lines in island  $S$  are restored, go to step.1 to build the next island ( $S+1$ ), otherwise go to step.4 to energize next transmission line (TL+1).

## B. Islands Interconnection.

This section analyses the power system stability issues at the last stages of restoration using WAMS. Two issues are investigated: firstly, unifying of the phase angle references in the disconnected islands; then, reaching a priority list to energize tie lines. At this stage the power system is considered as independent subsystems and the next action is to interconnect these islands to establish the bulk power system. To interconnect these subsystems, the angle difference across each tie line should be evaluated. The previous conventional monitoring systems that use RMS measurements are unable to estimate these differences synchronously and accurately. Improper connection of tie lines may disturb the power system and repeat the outage if the phase angle difference among its buses is big. Nowadays, WAMS, precisely performing phasor analysis over the whole power system that is able to define a reference phase angle to these subsystems so that the phase angle difference can be calculated synchronously across each candidate to be closed tie line. The data provided by the PMUs at different islands during restoration has been recognized. The PMUs measure the buses voltage phasor synchronously to a unique reference of these subsystems.

It should be noted that during the restoration process, the actual phase angle differences will be evaluated using direct measurement of PMUs at different islands and carrying out a state estimation over actual WAMS data and the tie line energizing priority list is identified. But it is noteworthy that, there is a great limitation for modeling and simulation of phase angle differences among the disconnected islands and in order to overcome the complexity of this simulation, a power flow analysis is done.

Actually, each island has its own BSU that is accepted as slack bus with the reference phase angle of island, and each island is restored independently based on its slack bus.

To interconnect these subsystems, all islands slack buses should be referred to a unique reference. It is essential to calculate phase differences of these so-called reference phase angles towards a unique reference which is almost chosen as one of the islands' slack buses. This process is called phase angle unification across independent islands and to do that practically, a power flow study should be carried out before the restoration process, in order to calculate the phase angle differences among the slack buses of the adjacent islands. These differences are then served as indicators to set slack generators' phase angles. Major assumptions during this study depend on the most probable state of generators, loads and transmission lines...etc. at the end of islands organization stage before interconnection process. Use generators output and picked loads prior to carrying out the interconnection considering tie lines, which are energized at the first steps of islands interconnection to perform this power flow.

The priority to energize tie lines is based on the SPA across them assuming constant voltage magnitude profile on both sides. Tie lines including smaller SPAs will be energized faster than those with greater ones. It is noteworthy that after closing the first tie line, SPA difference across the other tie lines will be changed. It is noted that after establishment of the first interconnections and synchronizing the subsystems, there will be a smoother phase angle profile throughout the power system. Hence, the priority list is not updated after carrying out the interconnections.

After SPA analysis, if SPA across a tie line which is planned to be energized is more than the predetermined threshold, the SPA reduction module will be consequently called. In accordance with the practice of the power system operators, if SPA reduction is required at the point of interconnections, generators and voltage regulators either in one or both of the subsystems can remove the excessive differences. It is noteworthy after synchronization is achieved, that there is no

difference between the reference phase angles of the adjacent islands.

The major steps to interconnect stable subsystems based on final state of all island and the phase angle across each tie line is described and the following steps identify the proposed algorithm to interconnect these subsystems and complete the process of integrating the BPS:

**Step9:** If all islands are restored, calculate the phase angle difference across each candidate tie line then arrange the tie lines to establish its energizing priority list.

**Step10:** According to the energizing priority list, energize tie line (*T*) to connect islands and energize the rest of unenergized branches inside islands

**Step11:** If all tie lines between islands are connected or the bulk power system is established, restore unserved loads otherwise go to step 10.

**Step12:** Follow after restoration.

#### IV. System descriptions

Some modifications, made on the New England 39-bus power system [27], resulted in the test system of the research [15] and are used for application of the approach using the buildup strategy and these modifications are as follows:

- The New England 39-bus power system is divided into four islands with thirteen PMUs as shown in Fig.1 and Tables. 1 and 2. All the islands are observable, each of which contains the active load more than minimum power generation to ensure its stability. In addition, the BSUs are assumed to be slack buses of the islands.

- Based on the optimal cranking restoration sequence algorithm and the PTDF based load restoration path sequence algorithms, the optimal restoration path sequence timing table for each island is identified in Table.3.

- Different types of Governors are used for generators as shown in Table.1. Standard Dig SILENT models for governors and exciters are used [25]. IEEE AC1 Excitation model is used as AVR model for all generators. Standard Dig SILENT Turbine Governor Models are used based on data in Table.1. Also Dig SILENT static load model is used to express all loads.

- The total time to complete different types of Generic Restoration Actions (GRAs) are presented Table.4 [16].

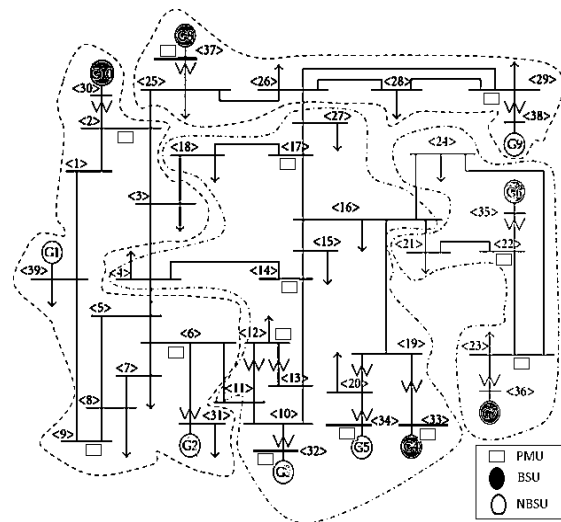

**Fig.1: The modified New England 39 bus power system.**

**Table.1: Some modification on the New England 39-bus system**

Type	Location
Phasor Measurement Units [PMUs]	2, 6, 9, 12, 14, 17, 22, 23, 29, 32, 33, 34, 37.
Black Start Units [BSUs]	30, 33, 36, 37.
Load Centers [LCs]	39, 4, 20, 3, 8, 24, 28, 29, 23, 7, 15, 27, 18, 21, 26, 25, 16.
Steam turbine generators	32, 34, 39
Gas turbine generators	30, 31, 35, 38,
Hydropower generators	33, 36, 37.

**Table.2: System sectionalized network islands buses**

Island No.	Buses	Total Generation[ MW]	Total Load [MW]	Total Inertia [s]
1	30 , 2 , 1 , 39 , 9 , 8 , 7 , 5 , 6 , 31 , 3 .	1770	2180	13.56
2	33 , 19 , 20 , 34 , 16 , 17 , 18 , 27 , 15 , 14 , 4 , 13 , 12 , 11 , 10 , 32 .	1790	2210	12.16
3	36 , 23 , 22 , 21 , 35 , 24 .	1210	880	6.03
4	37 , 25 , 26 , 28 , 29 , 38 .	1370	920	17.9

**Table.3: Restoration timing for applying build up strategy on the New England 39 bus.**

Island.	Line	30 - 2	2 - 1	1 - 39	39 - 9
	1	Time	20	25	30
1	Line	9 - 8	8 - 7	7 - 6	6 - 31
	Time	55	70	85	90
1	Line	2 - 3			
	Time	150			
2	Line	33 - 19	19 - 20	20 - 34	19 - 16
	Time	20	25	40	45
2	Line	16 - 15	15 - 14	14 - 13	13 - 10
	Time	75	90	95	100
2	Line	10 - 32	16 - 17	17 - 18	17 - 27
	Time	105	125	130	135
2	Line	13 - 12	14 - 4		
	Time	180	185		
3	Line	36 - 23	23 - 22	22 - 35	22 - 21
	Time	20	35	40	60
3	Line	23 - 24			
	Time	75			
4	Line	37 - 25	25 - 26	26 - 29	29 - 38
	Time	20	35	50	55
4	Line	26 - 28	29 - 28		
	Time	130	180		

**Table.4: Time to complete GRA [16].**

GRA Time	(min.)
Restart BSU	15
Energize a bus from a BSU/bus/line	5
Crank a NBSU from a bus	15
Pick up load	10

## V. Simulation results

The most critical decisions at early stages such as the load pickup steps during building up subsystems is decided based on transient stability study using DigSILENT Power Factory 14.1.3 software package [25] to ensure successful restoration process. To ensure the smoothing transient stability and to stabilize the voltage and frequency between the two consequent loadings, switching of loading step is assumed to be every 10 minutes as mentioned in the GRA table [16] to stabilize the voltage and frequency between the two consequent loading steps. In order to validate the results for the proposed approach and have detailed investigation of studying stability during restoration, more precisely, the dynamic response of island 4 is discussed below.

### A. Island 4 Simulation Results.

All simulations are done by using Dig SILENT Power Factory 14.1.3 assuming complete shutdown and the initial state of the simulation include opening of all circuit breakers in the test system. In order to have a detailed investigation of the restoration of loads, island 4 is selected for more detailed analysis. The time line for restoring island 4 is described as shown in Table.3. This timing schedule is based on the aforementioned restoration sequence and generation characteristics. Considering the loading sequence of these buses, it can be concluded that:

- After 55 min of restoration start up, buses 25, 26, 29, 37, and 38 are restored.
- In order to avoid lightly loaded transmission line energization, closing transmission lines 26-28 and 29-28 is deferred (130 and 180 min, respectively).
- Loading at bus 28 is started after its energization (150 min),
- For the New England 39-bus system, the loading steps are assumed to be **40 MW/10 min**, which is supposed to be the



total load of a sub transmission transformer.

- In comparison with the timeline of the available generation in the island, there is a time difference between the energization of the buses and their loading schedule. This difference is rooted in the required time for load pick up which is assumed to be **10 min.**

Load pickup time schedule of the buses included at island 4 is illustrated in Fig.3. In order to validate the results of this loading schedule, more precisely, the dynamic response of island 4 is shown in Figs.2 to 6. These figures illustrate electrical power generation, loading sequence, electrical frequency, oscillations of the rotor angles of generators and the voltage monitoring at different buses of island 4, respectively. It is noted that generator G8 at bus 37 is believed to be the slack bus of island 4, so its rotor angle is constant. All things considered, it can be concluded that:

- The active power generation of generators G8 and G9 during building of island 4 is shown in Fig.2. It is noted that loading of G8 is started at time  $t=40$  min as the load located at bus 25 is picked up. Before generator G9 start-up, only one loading step increase (40 MW) occurs at each step; 90 min after start-up of the whole process, two loading steps (80 MW) are available at each step; then 130 min after restoration start-up, the loading steps are again changed to 40 MW as there is only one load remaining. As a result, it is supposed that further loading will be added up after establishment of the BPS.

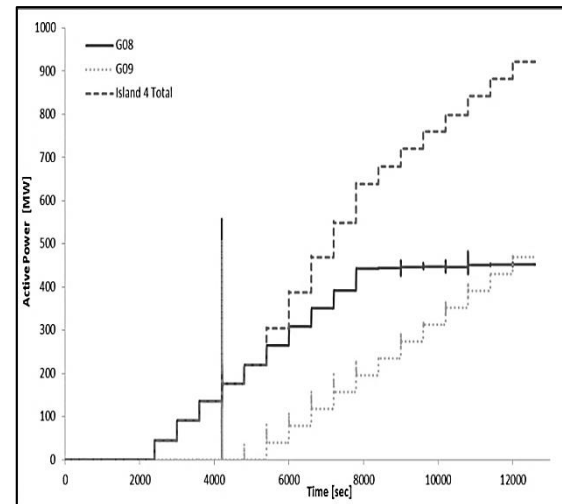

*Fig.2: Power generation at island 4*

- The loading sequence of island 4 during building the island is shown in Fig.3. It can be noted that loading at bus 25 is started at time  $t=40$  min, then the load is increased according to the loading steps. After generator G9 start up at  $t=70$  min (two loading steps are available) loading at bus 26 is started at  $t=80$  min. After finishing the loading of bus 25, loading of bus 29 is started at  $t=90$  min after being available. In order to avoid lightly loaded transmission line energization, closing transmission lines 26-28 and 29-28 is deferred (130 and 180 min, respectively) so loading at bus 28 is started after its energization (150 min). The delay of loading bus 28 is to avoid high voltage and waiting until there is available generation to pick up this load as it can be noted that before 130 min we have two loading steps for two loads 26, 29. Compatible with the load pickup schedule as shown in Fig.3, power generation is increased and there is also no operational problem.
- The electric frequency of generators G8 and G9 at island 4 during restoration process is shown in Fig.4. It is noted that the minimum steady-state frequency is more than 0.97 pu which is acceptable.

After generator G9 start-up and its interconnection with the transmission system, the electrical frequency of generators G8 and G9 would be the same.

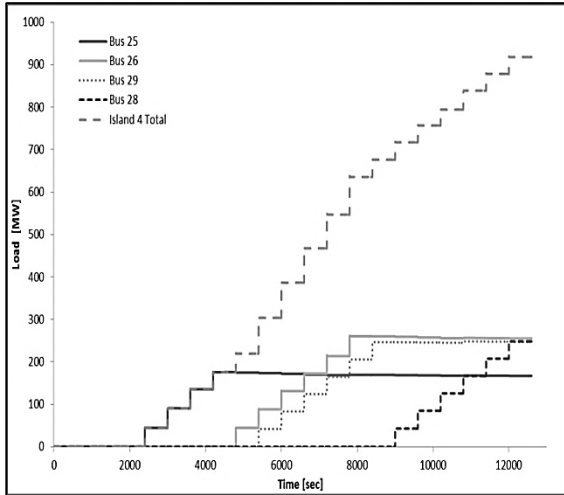

**Fig.3: Loading sequence at buses of island 4 of the New England 39-bus system**

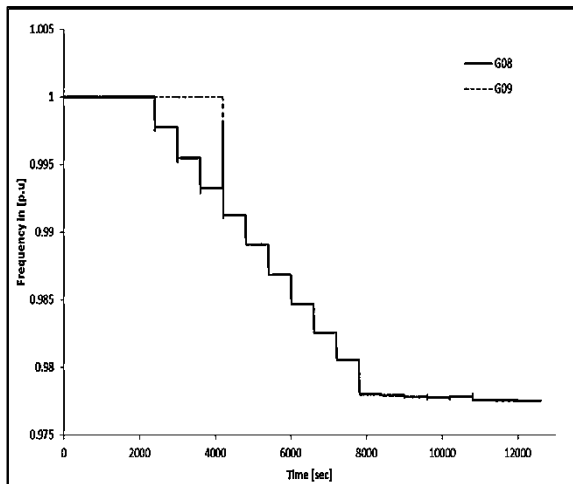

**Fig.4: Electrical frequency oscillations at island**

- The rotor angle of generators G8 and G9 at island 4 during restoration process is shown in Fig.5. It is noteworthy that generator G8 is believed to be the slack bus of island 4, so its rotor angle is constant. It is noted that the changing in the rotor angle of generator G9 as shown in Fig.5 has its roots in power dispatch between these generators.

- The voltage profile at each bus in island 4 during restoration is discussed and shown in Fig.6. The results reveal that the voltage of each bus is within acceptable limits. If we have an overvoltage when energizing any line, actions to reduce this overvoltage should be taken to return the voltage to acceptable limits. It can be noted that reactive power problem is fulfilled locally by operators using means of control devices such as adjusting generators reactive power, switching on/off FACTS devices and adjusting transformers tap.

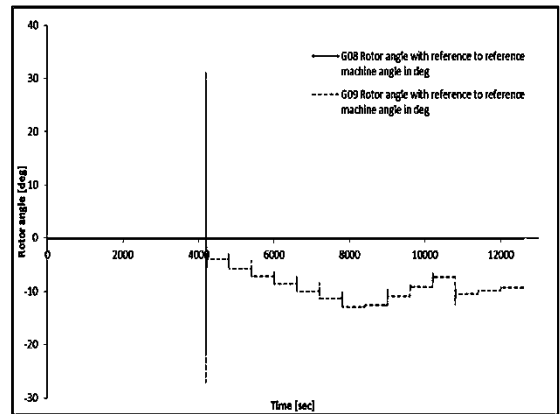

**Fig.5: Rotor angle oscillations at island 4 of the New England 39-bus system**

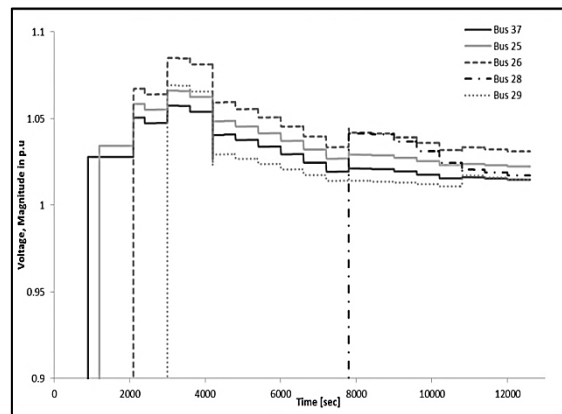

**Fig.6: Voltage RMS values of buses**

- In order to investigate the loading schedule, the loading steps are increased so that the power system loses stability.

It is concluded that, at island 4, considering the proposed parameters for the AVRs and turbine governors GOVs, loading steps greater than 46 MW will result in power system transient instability as shown in Figs.7-a and 7-b.

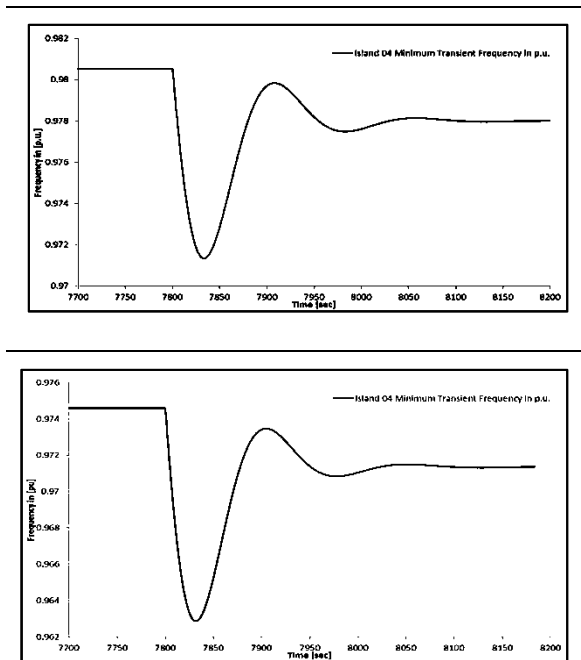

**Fig.7:** minimum Transient frequency of island 4 of the New England 39-bus system (a) loading step is 40 MW/10 min (b) loading step is 48 MW/10 min

### B. Total Results For All Islands

Applying the restoration procedure to all islands, it is noted that after 200 min of restoration start-up, all the islands are organized; however, island 3 reaches its final state earlier than the other islands (at 170 min). The Status of all islands at 200 min is presented in Table.5. The total generation and loads of all islands during restoration process and the electrical frequency oscillation of all islands which reveal that all islands are restored with acceptable frequency is shown in Figs.8 and 9. It should be noticed that 68 % of the system total loads are restored before the interconnection of islands and unserved loads will be added later. The minimum steady state frequency of all islands is 0.9756 pu that is

greater than 0.97 pu which is acceptable. It indicates that all islands are restored without any violation in frequency. Now the next restoration action is to interconnect tie lines between islands as it is still opened.

**Table.5:** The simulation results of all islands

Island No.	Total Generation	Total Load	Restored Time	Restored Load	Loading Steps	Minimum Transient Frequency	Steady State Frequency
1	1770	2180	200	1240	40	0.9736	0.981
2	1790	2210	200	1200	40	0.98	0.9851
3	1210	880	170	880	40	0.9703	0.9756
4	1370	920	200	920	40	0.9714	0.9776
Total	6140	6190	-	4240	-	-	-

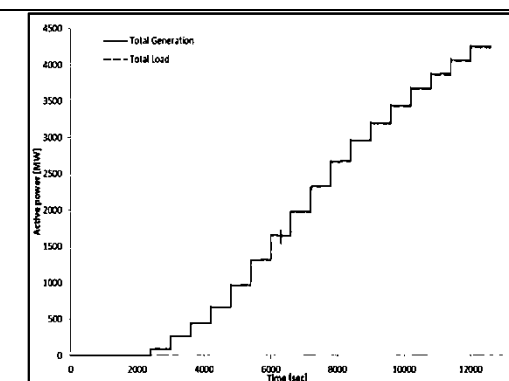

**Fig.8:** Total generation and Total Load of all islands of the New England 39-bus system

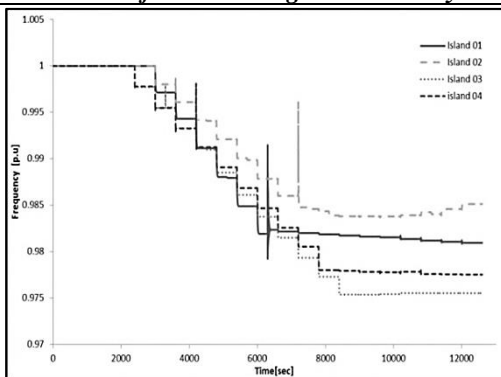

**Fig.9:** Electrical frequency oscillations of all islands of the New England 39-bus system

### C. Simulation Results of Island Interconnection

Owing to the simulation results of the New England 39-bus power system as presented in the previous section, at the end of the island organization stage (200 min), all the islands are stable and ready to be interconnected. The generator output and picked loads prior to interconnection is shown in Table.6.

- The data in Table.6 is used to carry out a power flow study on the test system to calculate the phase angle differences among the slack buses of the adjacent islands. Assuming bus 30 is the unique reference bus and the important tie lines is interconnected; the power flow results in the angles shown in Table.7. These angles are then served as indicators to set slack generators' phase angles at each island. Hence, during restoration process, all the phase angles are unified to unique reference bus 30. The SPA analysis along tie-lines and the priority list of energizing tie-lines is shown in Table.8; in addition the unenergized branches procedure is shown in Table.9.

**Table.6: Generation and loads prior to interconnection process**

Gen	G10	G1	G2	G4	G5	G3	G7	G6	G8	G9
Active Power [MW]	283	549	411	342	512	354	492	390	452	469
Bus No.	39	8	7	3	16	20	15	18	27	4
Load [MW]	656	248	165	173	325	303	203	162	163	41
	23	21	24	25	26	29	28			
	252	294	332	167	255	247	248			

**Table.7: the relative phase angle differences of islands 2-4 Compared with the slack bus of island 1**

Bus	Voltage, Angle [deg]
30	0
33	4.1
36	7
37	3.3

**Table.8: Tie Lines Priority List based on SPA Difference**

From Bus	Bus Angle	To bus	Bus Angle	Difference	Energizing Time
26	-12.3793	27	-12.1362	0.24302	210
4	-4.8181	3	-3.1504	1.667645	220
16	-8.88302	24	-11.016	2.133753	230
16	-8.88302	21	-6.3679	2.515041	240
6	-2.93201	11	0	2.932006	250
4	-4.8181	5	0	4.818101	260
2	-1.75708	25	-7.2957	5.538624	270
3	-3.15046	18	-11.291	8.141054	280

**Table.9: Unenergized branches closure time**

Branch	Time
11-12	255
11-10	260
5-8	265
5-6	270

- The establishment plan of the transmission system is as shown in Table.8 as follows: Tie line 26-27 is energized at the first step of the islands interconnection process (210 min) interconnects islands 4 and 2. Afterwards, Tie line 3-4 is energized at the second step of the islands interconnection process (220 min) interconnects islands 4, 2 and 1. Afterwards, Tie line 16-24 are energized at the third step of the islands interconnection process (230 min) interconnects islands 4, 2, 1 and 3 results in establishing of bulk power system BPS

- In order to evaluate the simulation results, tie line 26-27 is chosen for a more detailed analysis. Fig.10 shows the active power flow through tie line 26 - 27 integrating islands 4 - 2. According to Fig.10 that shows the operational dynamics of tie line 26-27 during the period of 210-280 min, it should be noted that at 230, 270 and 280 min throughout energizing transmission 16-24, 2-25 and 3-

18 , power flow through tie line 26-27 experiences some changes. Furthermore, energizing the aforementioned transmission lines at 220, 240, 250 and 260 min creates some changes in the power flow of this tie line as well as the voltage difference across it. These changes are not as severe as the aforesaid ones.

- Actually; changes in the system configurations also affect the RMS voltage of these buses. Fig.11 and 12 shows changes of the voltage RMS values and angle of buses 26 and 27 of the New England 39-bus system as a result of restoration execution .These changes are in remarkable accordance with those of the power flow as shown in Fig.10.

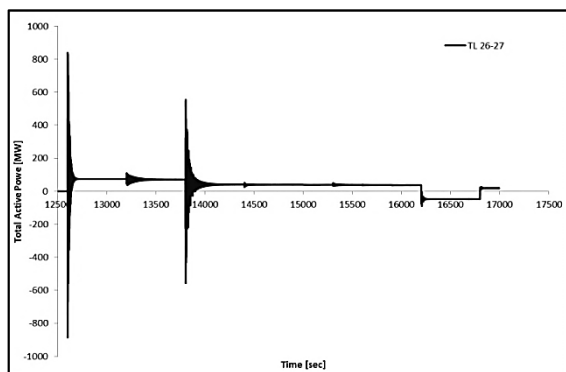

**Fig.10: Active power flow through tie line 26-27**

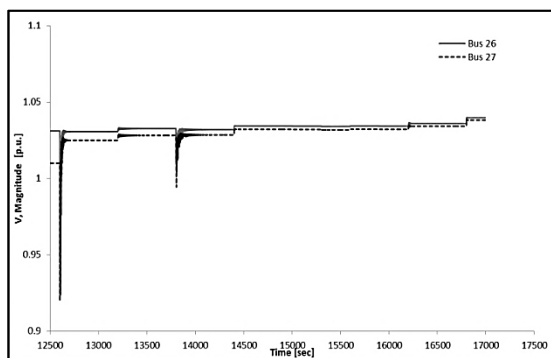

**Fig.11: Voltage RMS values of buses 26 and 27**

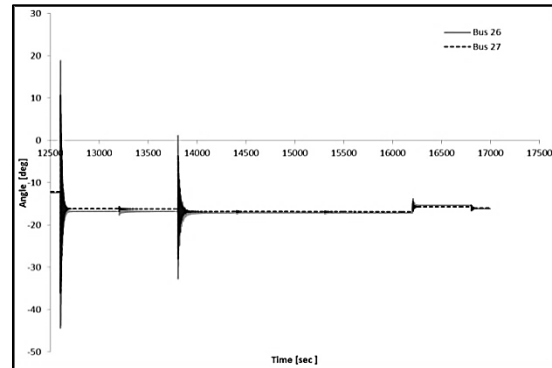
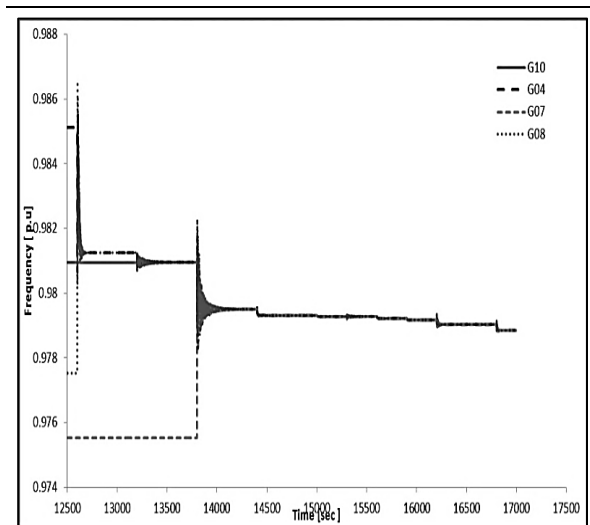

**Fig.12: Voltage angle values of buses 26 and 27**

- Figure.13 illustrates the electrical frequency variations at generators 10, 4, 7 and 8 at buses 30, 33, 36 and 37 which are located in different islands. This Figure is to show the process of frequency adaptation throughout the power system. For example, taking the first step of islands interconnection leads to the frequency adaptation of islands 2 and 4 (210 min). The second step of islands integration, leads to frequency adaptation of islands 4, 2, 1. The final step of islands integration which results in creation of the BPS (230 min) causes frequency adaptation throughout the whole power system.

- The power system dynamic response to this PBS establishment plan is shown in Fig.14. This Figure shows the rotor angle oscillations of generators at buses 30, 33, 36 and 37 compared with the reference phase angle (generator G10) at bus 30

- Finally, after connecting all tie lines, the BPS is established and further loading can be added now, hence the system enter the normal operation state.



*Fig.13: Electrical frequency oscillations at G10, G4, G7 and G8*

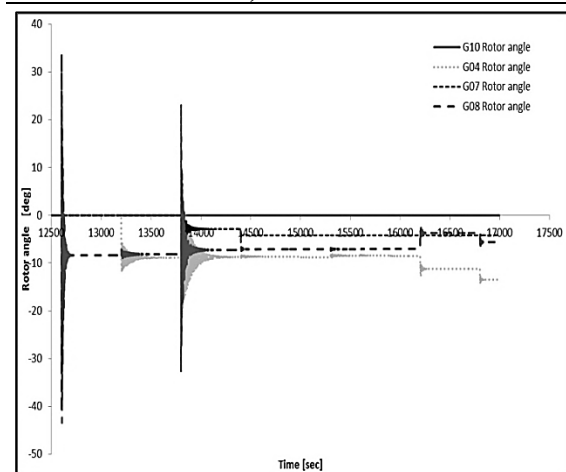

*Fig.14: Rotor angle oscillations during the PBS establishment*

## VI. Conclusions

Power system stability issues during restoration were analyzed in this paper. Online stability assessment was achieved depending on power system variables estimation using WAMS data. Two algorithms for stability issues were introduced according to the restoration planning method using the build-up strategy; the first one includes the critical decision about generator loading steps during load restoration at first stages of restoration and the other includes the interconnection process of islands to establish the BPS at the

last stages of restoration. These stability issues are analyzed on the New England 39-bus power systems using Dig SILENT power factory software and the simulation results reveal the remarkable applicability of the proposed approach for restoration.

The net results are comprehensively evaluated in order to investigate the impact of the WAMS data on the results. Applying the restoration procedure to all islands it can be noted that all islands are restored with acceptable frequency. At the last stages, synchronized measurements provided by WAMS leads to unification of phase angles references at disconnected islands to a unique reference. This leads to monitor the voltage angle across each candidate line to be closed. The tie line energizing priority list is established. The adjacent islands were interconnected in order to establish the BPS. The results reveal applicability of the proposed approach for power system restorations. The net results of the presented approach will lead to a great promotion in power system restoration methodologies using WAMS.

## VII. References

- [1] M.M.Adibi and R.J. Kafka, "Power system restoration issues," IEE Comput. Appl. Power, 1991, 4, (2), pp. 19–24.
- [2] M.M. Adibi, et al. , "Power system restoration - a task force report," IEEE Transactions on Power Systems, vol.2, no.2, pp.271-277, May 1987.
- [3] M.M. Adibi, J.N. Borkoski and R.J.Kafka, "Power system restoration - the second task force report," IEEE Transactions on Power Systems, vol.2, no.4, pp.927-932, Nov. 1987.
- [4] M.M.Adibi and L.H.Fink , "Power system restoration planning," IEEE Trans. Power Syst., 1994, 9, (1), pp. 22–28.
- [5] IEEE Committee Report , "Special considerations in power system restoration," IEEE Trans. Power Syst., 1992, 7, (4), pp. 1419–1427.

- [6] L. H.Fink, K. L. Liou and C.C. Liu , "From generic restoration actions to specific restoration strategies," IEEE Transactions on Power Systems, vol.10, no.2, pp.745-751, May 1995.
- [7] J.N.Jiang , Z.Zhang, M. Fan, G.Harrison, C. Lin, M.Tamayo and V.Perumall , "Power System Restoration Planning and Some Key Issues," IEEE Trans Power Syst ,2015,pp1-8.
- [8] T.Venkatesh, T.Jain , "Intelligent-search Technique based Strategic Placement of Synchronized Measurements for Power System Observability," Expert Systems with Applications, Volume 42, Issue 10, 15 June 2015, Pages 4768-4777.
- [9] A.Golshani, W.Sun and Q.Zhou, "Optimal PMU Placement for Power System Restoration," IEEE Trans Power Syst ,2015,pp 1-5.
- [10] A.G.Phadke and J.S.Thorp," Synchronized phasor measurements and their applications," Springer, 2008.
- [11] J.De La Ree, V.Centeno, J.S.Thorp and A.G Phadke , " Synchronized phasor measurement applications in power systems," IEEE Trans. Smart Grid, 2010, 1, (1), pp. 20–27
- [12] A.Bose , " Smart transmission grid applications and their supporting infrastructure," IEEE Trans Smart Grid, June 2010;1(1):11–9.
- [13] A.G. Phadke, R.M. de Moraes," The wide world of wide-area measurement," IEEE Power Energy Mag ,2008;6(5):52–65.
- [14] S.A.Nezam-Sarmadi ,A.S.Dobakhshari ,S.Azizi ,A.M. Ranjbar , " A sectionalizing method in power system restoration based on WAMS," IEEE Trans. Smart Grid, 2011, 2, (1), pp. 190–197
- [15] S. Nourizadeh , S.A. NezamSarmadi , M.J. Karimi, A.M. Ranjbar , "Power system restoration planning based on Wide Area Measurement System" ,Electrical Power and Energy Systems 43 (2012) 526–530.
- [16] C.C .Liu, V.Vittal, G.T.Heydt, K.Tomsovic, W Sun," Development and Evaluation of System Restoration Strategies from a Blackout,"Final Project Report, Power Systems Engineering Research Center, PSERC,Publication 09-08, September 2009.
- [17] W. Liu; Z. Lin; F. Wen, G.Ledwich, "A wide area monitoring system based load restoration method," Power Systems, IEEE Transactions on , vol.28, no.2, pp.2025,2034, May 2013
- [18] J.Jiao,W.Long,et al,"A service restoration method based on load balance expectation searching for smart distribution grid,"Electricity Distribution (CICED),2014 China International Conference on.IEEE,2014.
- [19] S.Nourizadeh,M.J.Karimi,A.M.Ranjbar, and A.Shirani,"Power system stability assessment during restoration based on a wide area measurement system,"Iet Generation Transmission&Distribution,vol.6,no.11,p p.1171–1179,2012.
- [20] S.Nourizadeh,V.Yari,andA.M.Ranjbar," Frequency Monitoring and Control during Power System Restoration Based on Wide Area Measurement System,"Mathematical Problems in Engineering,vol.2011,Article ID 489841,13 pages,2011.
- [21] M.Larsson,"An adaptive predictive approach to emergency frequency control in electric power systems'.Proc.44th IEEE Conf.Decision and Control,and the European Control Conf.2005,Seville,Spain,12–15 December 2005
- [22] H.Hijazi,T.Mak,P.V.Hentenryck,"Power System Restoration With Transient Stability.AAAI Conference on Artificial Intelligence,North America,feb.2015.
- [23] S.Singh,A.Alka,andK.K.Swarnkar,"Power system restoration using particle

- swarm optimization,"International Journal of Computer Applications 30.2 (2011).
- [24] M.Mak,W.K.Terrence,et al,"Power system restoration planning with standing phase angle and voltage difference constraints,"Power Systems Computation Conference (PSCC),2014.IEEE,2014.
- [25] DIgSILENT PowerFactory,Version 14.1, User's Manual,Volume I, User's Manual,Volume II, Edition 1, DIgSILENT GmbH, Gomaringen, Germany, May 2011.
- [26] P.Kundur,"Power system stability and control,power system engineering series,"(McGraw-Hill,New York,1994.
- [27] IEEE 10 Generator 39 Bus System [Online].Available: [sys.elec.kitami-it.ac.jp/ueda/demo/WebPF/39-New-England.pdf](http://sys.elec.kitami-it.ac.jp/ueda/demo/WebPF/39-New-England.pdf)