

## Loop Control and Tuning in Distributed Control System Using Fuzzy Controller

التحكم و الموائمة في الدوائر المغلقة لنظم التحكم الموزعة باستخدام منطق عدم التحديد

M. Abdel-Geliel and A. Khalil

Electrical Eng. and Automatic Control Dept., College of Eng. & Tech., Arab academy for science and technology, Alex., Egypt.

في هذا البحث يتم تقديم طرق ضبط وموائمة عوامل مقياس الدخل و الخرج لنظام تحكم بمنطق عدم التحديد. الطريقة المقترحة تعتمد على استعمال اثنان من نظم التحكم بمنطق عدم التحديد احدهم هو الاساس للتحكم في المتغير المراد التحكم فيه والثاني لضبط عوامل مقياس الدخل والخرج للاول بناء على نظرية استعمال نظم الموائمة باستخدام نموذج مرجعي للمنظومة.

من اهم مميزات هذه الطريقة انها تصلح لكثير من النظم الصناعية و خصوصا النظم الكبيرة التي تعتمد في تشغيلها على نظام التحكم الموزع. وقد تم اختبار هذه الطريقة على نموذج معلمي يمثل احد المنظومات الصناعية المسوولة عن تسييل الغازات البترولية وخصوصا التحكم في درجة الحرارة المستوى للنظام. و قد تمت مقارنة النتائج مع النواتج التي تعتمد على الضبط اليدوي و الضبط باستخدام نظم الموائمة التقليدية و قد اوضحت النتائج كفاءة الطريقة المقترحة.

*Abstract-* In this paper, the designed schemes for two fuzzy controllers, employing the scaling factor tuning, are proposed. The first fuzzy logic controller is a normalized controller used to control the system. The tuning for the input and output-scaling factors of the first one is done through the second fuzzy controller (the supervisory controller). This combination is used to appropriately determine the control signal of the process. The supervisory fuzzy controller tunes the normalized fuzzy controller based on the model reference adaptive control technique. The great advantage of the proposed method is that, a supervisor as a fuzzy controller to tune the scaling factor of a normalized fuzzy controller can be used to supervise many control systems. The simplicity and modular structure of the controller makes it is more suitable to be applied to control most control loops in the distributed control systems (DCS). The normalized fuzzy controller and the supervisory fuzzy controller are organized with specific experience information about the controlled systems. The proposed fuzzy controllers are applied experimentally to control an experimental process, which simulate an LPG process. The proposed controller is applied to two different control loops, temperature and level, where the controller gains are selected based on the process conditions and limitations. A comparison among scaling factor manual tuning, supervisor fuzzy and conventional adaptive fuzzy controller is done to verify the effectiveness of the proposed design. The results show that in the last case the system is forced to follow the desired response.

**Key Words:** Normalized fuzzy controller, supervisor fuzzy controller, scaling factor tuning, and DCS systems.

### 1. INTRODUCTION

Modern industrial processes become more complex in order to achieve the essential requirements of modern civilization. The complexities of industrial processes increase control tasks in order to achieve the system requirements and goals. A single control system (central controller) has a less capabilities to achieve whole control tasks due to the complexities of control algorithms and the computation burden. Therefore, a distributed control system (DCS) is preferred. Several control techniques are suggested, in literature, to be implemented in real industrial processes starting from simple techniques to very complicated one such as PID, MPC (Model Predictive Control), AI (Artificial Intelligent), Robust, adaptive etc... The PID controller is the most popular controller, which is implemented in most real industrial processes either SISO or MIMO system, due to the simplicity and robustness of the PID controller in addition to it is easy to understand and operate by the human operator, [1], [2]. The dynamic characteristics of most control systems are not constant because of several reasons, such as deterioration of components as time elapse or change in parameters and environment. A satisfactory system must have the ability to adaptation. Adaptation implies the ability to self-adjustment or modification in accordance with an unpredictable change in the conditions of the environment or structure. Due to this reason, a human supervision is necessary all the time in order to limits the system variations. In order to avoid

the instability and less accuracy of process performance, the human supervisory play an important role in process adjustment and operations. Since, most of industrial processes are continuous and complex process and the process identification has many approximations such as LPG processes [3]. The conventional controller cannot handle all situations of the process, which mainly depends on the system model. An adaptive system is necessary to adapt the controller parameters. Moreover, the controller used in such process must be fast and simple because of the huge number of controlled variables and to reduce the computational burden.

In many cases, the physical measurements of the pertinent quantities are very difficult and expensive. These difficulties lead to explore the use of "Artificial Intelligence" (AI) [4]-[9] as a way of obtaining models based on the experimental measurements. Artificial Intelligent control technique requires a well known about the process operation (experience) in order to construct/learn the controller of the process variables. However, all the process situations may take place during operations inconsiderable during controller construction and start up so, the adaptation method is also necessary for AI controller [5]. Hence, Due to these reasons, an adaptive controller with some experience of the process and without actual process model is preferred to adjust the variable response in most of the process situations and reduce the effort on the human supervision.

An adaptive fuzzy controller is suggested to control and adapt the DCS system loops. This algorithm is

constructed and tested on an experimental model, which simulates part of control loops of the deethanizer Liquefied Petroleum Gases (LPG) recovery process.

One of the superior capabilities of fuzzy system, as an AI technique, is that it can use the information expressed in linguistic pattern. Though most fuzzy system have been formed to emulate human decision making behavior, the linguistic information stated by an expert may not be precise, or it may be difficult for the expert to articulate the accumulated knowledge to encompass all circumstances. Hence, it is essential to provide a tuning capability [9] for fuzzy system to generate or modify the controller parameters on line in real system and it is an important issue in intelligent control. Thus, the human operator (supervisor) is often required to provide on line adjustment, which makes the process performance greatly dependent on the experience of the individual operator [10]. The development of controllers capable of generating tuning parameters of fuzzy controller to obtain the desired dynamics for the plant is of a great importance. In this work, after a review of different adaptation of fuzzy controller proposed in literature [7], [9], [11], [12], [4] a fuzzy controller that self-adapts the parameters, mainly the input and the output gain coefficients is proposed, using only qualitative knowledge of the plant. The controller will start with a set of fixed parameters (normalized fuzzy controller with input scale factor and output scale factor) and through the supervisory fuzzy controller, the scale factors of the normalized fuzzy controller are adjusted or adapted. The adaptation of scale factors are done by two methods, the output-input scale factors are tuned according to the error between the reference input and actual output firstly. Finally input-output scale factors are tuned according to the error between the desired response and actual response (model reference adaptive technique) [13]. This adjustment is accomplished in continuous time. The analysis which shows the robustness of the proposed algorithms is performed for different real-time situation of the case study.

The paper is organized as follow: The proposed adaptive fuzzy controller is introduced and the controller structure and adaptation are explained in section II. General structure of the proposed algorithm is discussed in section III. The application and real implementation of the proposed algorithm are highlighted in section VI. Finally the conclusion is discussed in section V.

## II. ADAPTIVE FUZZY CONTROLLER CONFIGURATION

As stated before, PID is the most popular controller implemented in real DCS system, the operating conditions and the process parameters, such as temperature and pressure etc..., vary during the operation, and as a consequence the controlled variables cannot be sustained around the required margin. Due to this reason, a human supervision is necessary during the system operation in order to limits the system variations. The loop tuning is

done based on the human experience with some trial and error. In order to avoid the instability and less accuracy of process performance, the human supervisory play an essential role in process adjustment and operations. Since the real processes are large and require the fast response, it is difficult for human supervision to handle such type of process.

In order to reduce the human operator effort and to overcome the problem of PID parameter variation [1], a normalized Fuzzy controller with adjustable scale factors is suggested. Scale factors are adjusted according to the mechanism shown in Fig 1. The deviation of the process output from the desired performance, which is determined by the reference model, is the firing signal to adaptation mechanism.

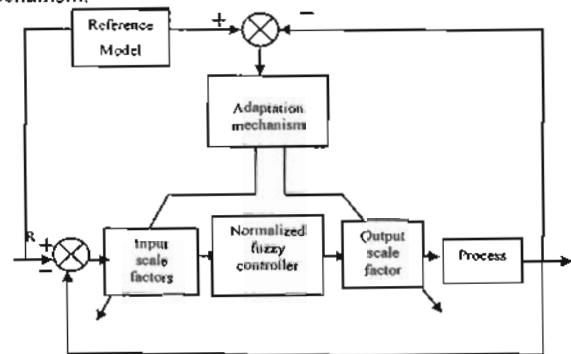

Fig. 1 General adaptation mechanism of Normalized fuzzy controller

The selected normalized fuzzy controller, which is to illustrate the idea, has the following parameters:

- Membership functions of the input/output signals have the same universe of discourse equal to 1.
- The number of membership functions for each variable is 5 triangle membership functions denoted as NB (negative big), NS (negative small), Z (zero), PS (positive small) and PB (positive big) as shown in Fig. 2.
- Fuzzy allocation matrix (FAM) or Rule base as in Table I.
- Fuzzy inference system is Mamdani.
- Fuzzy inference methods are "min" for AND, "max" for OR, "min" for fuzzy implication, "max" for fuzzy aggregation (composition), and "centroid" for defuzzification.

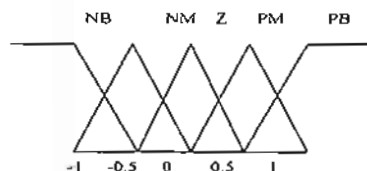

Fig 2 Normalized membership function of inputs and output variables

Table 1 FAM OF NONNORMALIZED FUZZY CONTROLLER

$\Delta e$					
$e$	NB	NM	Z	PM	PB
NB	PB	PB	PM	Z	Z
NM	PM	PB	PM	Z	Z
Z	PM	PM	Z	NM	NM
PM	Z	Z	NM	NB	NB
PB	Z	NM	NB	NB	NB

In the case of the normalized universe of discourse, an appropriate choice of specific operating areas requires scaling factors [7], [8]. An input scale factor transforms a crisp input into a normalized input in order to keep its value within the universe. An output-scaling factor provides a transformation of the defuzzified output from the normalized universe of the controller output into an actual physical output [7]. Some priority list of scale factor choice is recommended in [14]. Similarity between coefficients  $K_i$  and  $K_p$  of the PI controller and the scaling factors of the normalized fuzzy controller is analyzed in [8], [15]. Selection of scale factors by trial and error is suggested and recommended in [7]. In this study, firstly tuning scaling factor of input and output is achieved using adaptive techniques [8], [12], [13] taken into consideration the human experience. After that the tuning is achieved using another fuzzy controller (supervisor). In the two cases the procedure of tuning the factors is related to the research results in [16]. The main objective of supervisory controller is to tune on line the scale factors of the normalized fuzzy controllers. The tuning procedure depends on trial an error (human supervision) or adaptation algorithms.

The output gains of the adaptation mechanism can be determined based on the error signal between the reference input to the process and the actual output without model reference as shown in Fig. 3. In this case the system response can perform accepted specification but if it is desired to force the over-all system to achieve a desired specification such as overshoot, rise time etc... the output gains should be related to that specifications. Model reference adaptive technique is one of the adaptation methods used to force the system performance to achieve specified specifications [6],[13].

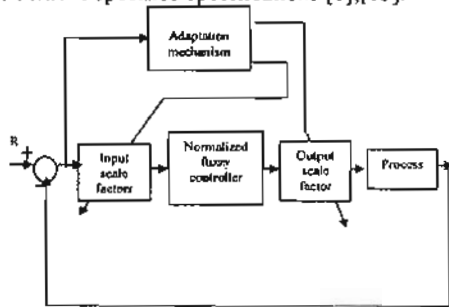

Fig. 3 Over-all Block of the process and supervisory fuzzy controller with the same input signal of the main controller

11.1 Control Structure and Operation

Adapting the scale factors of the normalized fuzzy controller can be carried out using different techniques, two methods are introduced and tested, GD (Gradient Decent) adaptation method and supervisor fuzzy.

11.1.1 OUTPUT SCALE FACTOR ADAPTATION USING GD ADAPTATION METHOD

The adaptive variable here is the output scale factor gain (de-normalization factor). Therefore, the GD method seeks to decrease the value of the quadratic objective function based on the instantaneous error  $e(k)$ :

$$J(k) = \frac{1}{2} e^2(k) \tag{1}$$

The error, here, is a plant output error  $e_y$

$$e_y(k) = y_m - y(k) \tag{2}$$

The performance index will be:

$$J(k) = \frac{1}{2} (y_m(k) - y(k))^2 \tag{3}$$

where  $y_m(k)$  is the reference-modeled output;  $y(k)$  is the actual output.

The overall block diagram of the adaptation system using GD method is shown in Fig. 4, we take the reference model output as a step.

The parameter set,  $\theta(k)$ , of the fuzzy scale factor is changed via the following iterative adaptation rule:

$$\begin{aligned} \theta(k+1) &= \theta(k) + \Delta\theta(k) \\ &= \theta(k) - \alpha \partial J(k) / \partial \theta(k) \end{aligned} \tag{4}$$

where  $\alpha$  is the adaptation parameter, which indicates how much the parameter is altered in each iteration, and  $\theta$  is the scale factor.

According to GD techniques [17], [9], [11] the derivative term will be:

$$\partial J(k) / \partial \theta(k) = e(k) \cdot \partial e(k) / \partial \theta(k) \tag{5}$$

then

$$\theta(k+1) = \theta(k) - \alpha \cdot e(k) \cdot \partial e(k) / \partial \theta(k) \tag{6}$$

According to the adaptation equation (6) we can deduce that response will depend on the following parameters: adaptation factor  $\alpha$ ; initial value of scale factor gains; and fuzzy system inference.

By fixing the fuzzy inference system (normalized fuzzy described above). Then the main parameters that affect on the response will be  $\alpha$  and  $\theta_0$ .

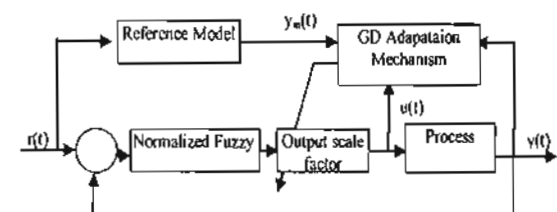

Fig. 4 Block diagram of GD adaptation system

The implementation of equation (6) is depending on the system and controller models and the derivative term is not easy to obtain in some application (non-differentiable). Hence the implementation of GD has some limitations in practical applications especially for output scale factor.

### II.1.2 FUZZY SUPERVISOR ADAPTATION

To avoid the limitation of GD especially if the system model is unknown or inaccurate, a supervisor fuzzy controller, as an adaptation mechanism, to change the scale factors on line is suggested. The design of the supervisor can be constructed by two methods:

a) Learning method [11], [12], [10], [18].

b) Experience of the system and main requirements must be achieved.

In this paper, the supervisor controller is built on line based on the accumulative knowledge of the previous tuning and operation. The supervisor fuzzy controller has the following parameters:

- the universe of discourse of input and output are selected according to the maximum allowable ranges and that depend on the process requirements
- The number of membership functions for input variables is chosen to be 3 triangle membership functions denoted as N (negative), Z (zero), and P (positive). For output variable is 2 membership functions denoted as L (low) and H (high) as shown in Fig. 5
- Fuzzy allocation matrix (FAM) as in Table 2
- Fuzzy inference system is Mandani.
- Fuzzy inference methods are "min" for AND, "max" for OR, "min" for fuzzy implication, "max" for fuzzy aggregation (composition), and "centroid" for Defuzzification.

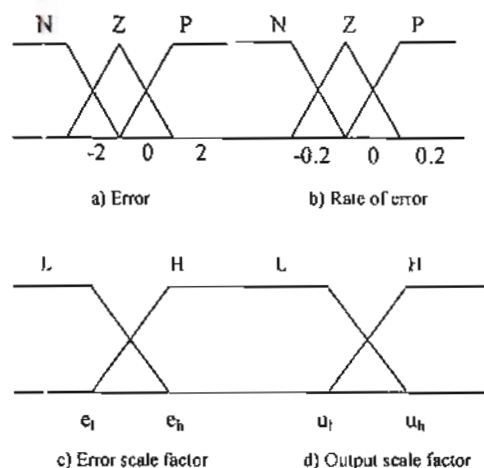

Fig. 5 Membership Function of inputs and output of supervisory fuzzy controller

Table 2 FAM OF SUPERVISORY FUZZY CONTROLLER

$\Delta c$	N	Z	P
N	H	H	L
Z	L	L	H
P	L	H	H

The overall block diagram of the model reference supervisor controller is shown in Fig. 1 by replacing the adaptation mechanism block by fuzzy controller. The input signals to the supervisory controller are the error (between the desired model and actual output of the process) and its rate of error.

### III. GENERALIZATION OF SUPERVISORY FUZZY CONTROLLER ON DIFFERENT PROCESS LOOP

The selection of the algorithm parameters (scale factor universe of discourse) for a certain loop is built based on some knowledge of the process variable. But if the same procedure would be applied to another process loop, the method of universe of discourse selection should be generalized. Hence, the algorithm should be capable of select the universe of discourse of the new variable will deal with.

In this section we try to show the method of selection the universe of discourse in any process loop.

#### III.1 UNIVERSE OF DISCOURSE SELECTION.

According to the previous algorithm, for any single-input/output process, there are three universe of discourse must be determined: error, rate of error, and control signal.

##### III.1.1 UNIVERSE OF DISCOURSE OF OUTPUT SCALE FACTOR (CONTROL SIGNAL) CALCULATION.

The output scale factor is selected based on the maximum control signal range  $u_{max}$ . If the controller is bidirectional ( $\pm$ ) then the maximum universe of discourse will be  $-u_{max}$  to  $+u_{max}$ . But if the controller is unidirectional ( $+$ ) then the maximum universe of the controller output range  $0-u_{max}$  and the output signal is calculated from the following equation:

$$u_o = u_{min} + s_o \cdot u_f \quad (10)$$

where  $u_o$  is final control signal,  $u_{max}$  is maximum allowable control signal,  $u_{min}$  is minimum allowable control signal,  $s_o$  is output scale factor and  $u_f$  is normalized fuzzy output.

In both cases the output scale of the supervisory fuzzy will change from  $\pm u_{min}$  to  $\pm u_{max}$  in bidirectional control signal and  $0-u_{min}$  to  $0-u_{max}$  in unidirectional control signal.

### III.1.2 UNIVERSE OF DISCOURSE OF ERROR AND RATE OF ERROR CALCULATIONS (INPUT UNIVERSE).

To calculate the input universe of discourse the process operates in two modes: proportional (course) mode; supervisory (fine) mode.

*i. Course mode:* the controller operates in this mode in two cases: Firstly; when the reference signal changes from step to another step. Secondary; when the error reaches predetermined value based on the specification of the allowable error required from the system decided by main supervisor (Human or other supervisory controller in Hierarchal system). The controller output in this case is maximum allowable value and the rate of error change is calculated continually in this period according to the following equations:

$$e(k) = y(k) - r(k) \quad (11)$$

$$\Delta e(k) = (e(k) - e(k-1)) / T \quad (12)$$

where  $y(k)$  is the actual output;  $r(k)$  is the reference input;  $e(k)$  : the error at sampling instant  $k$ ;  $\Delta e(k)$  is the rate of error at sampling instant  $k$ ;  $T$  is sampling time.

Record  $e(k)$  and  $\Delta e(k)$  until the error reaches a certain values determined by the main supervisor. After that the universe of discourses is calculated from the following equations:

$$U_e = 1/e_{\max} \quad (13)$$

$$U_{\Delta e} = 1/\Delta e_{\max} \quad (14)$$

where  $e_{\max}$  is the maximum allowable error required;  $\Delta e_{\max}$  is the maximum rate of error calculated during the proportional mode.

*ii. Fine mode:* in this case the calculated values of the universe of discourse of the inputs and outputs scale factors are used in supervisory fuzzy. The switching from course to fine mode is depending on the value of maximum allowable error between the actual and reference input, which is predetermined by the main supervisory.

According to the above analysis of scale factors universe calculations, there are two decision makers in the control system rather than the control algorithm suggested. The first decision maker is the main (global) supervisor (human or another supervisory controller) which decide the main set values of the process variable (maximum and minimum value of controller output, minimum and maximum allowable error, etc.). The second one is a logical controller which switches between the course and fine controller and computes the universe of discourse of input and output based on the set values of the main supervisory. The overall block diagram of supervisory controller in a multivariable process (or any DCS) is shown in Fig. 6. In this case one supervisor controller can handle more than one process variable where the sampling time for supervision is smaller than the sampling time of the process variable. Hence, each group of process variables are supervised by one supervisory controller the selection between them is achieved using multiplexer at the input of the supervisory and de-multiplexer at the outputs.

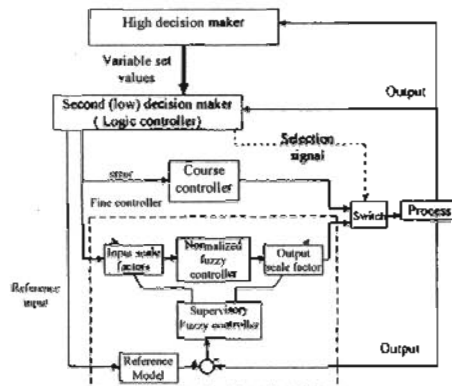

Fig. 6 Over-all block diagram of self adapted supervisory fuzzy

## IV. EXPERIMENTAL PROCESS

Most of real processes are of complex nature and contain MIMO variables. One of these processes is the process, which is one of the necessary processes in most refinery process crude petroleum oil. The LPG is a light saturated paraffinic hydrocarbon derived from the refinery process crude petroleum oil stabilization and natural gas processing plants. They consist mainly of propane (C3H8) and butane (C4H10) or combination of the two and some other hydrocarbons. They are mainly liquefied under pressure for transportation and storage.

The LPG recovery process is to separate the main components of LPG, C3H8, C4H10 and the other hydrocarbons. The separation takes place at a certain heating temperature. One of the LPG recovery process, in ANRPC Petroleum Company in Egypt, starts by Deethanizer (Ethan separation C2H6) process followed by Depropanizer and Debutanizer process. The schematic diagram of LPG recovery process is introduced in [3]. Deethanizer recovery process is a part of LPG recovery process. The schematic Diagram of the Deethanizer recovery process is shown in Fig. 7. Treated LPG is feed to the upper of the separation tower and the outlets of the tower are Ethan and treated LPG. The Deethanizer Recovery process requires a certain conditions of temperature, level and pressure. Each process variable (Temperature, Level and Pressure) in the recovery process is controlled by an individual control loop in the DCS. PI controller is the main controller for almost control loop. The temperature of Ethan produced is controlled through deethanizer reboiler by changing the steam flow rate to the reboiler. The Ethan temperature must be maintained at 420 °c all the time. The heating of LPG is performed using steam and variation in the steam flow rate lead to the variation of the process temperature. Hence process temperature is controlled by adjusting the inlet steam and outlet condensed water flow rate to and from the reboiler unit as in Fig. 7. Where the steam conditions (pressure and temperature) vary during operation, the temperature controller cannot maintain the temperature around the allowable range 420°C ± 2%. Due to this reason, a human supervision is necessary all the time in order to limits the

system variation. The loop tuning is done based on the human experience with some trial and error. In order to avoid the instability and less accuracy of process performance, the human supervisory play an important role in process adjustment and operations.

This type of process is a continuous and complex process and the process identification has many approximations. The conventional controller cannot handle all situations of the process, which mainly depends on the system model.

Since it is difficult to test directly the suggested controller in real time on the LPG process due to the practical considerations, a small prototype for the thermal and level loops of the LPG recovery process are constructed as shown in Fig. 8, which simulate the tank and reboiler unit in the Deethanizer of LPG recovery process.

The thermal loop is a single input-single output system (SISO). The apparatus consists of a versatile controller, an electrically heated model process and condition unit. The model is an electrically heated, aluminum process block surrounded by a water jacket, into which is inserted a platinum resistance thermometer. The model is designed so that it is, in effect, a speed up version on an industrial process with time constants shortened, to make the experiments of suitable duration for university engineering laboratories.

The control problem investigated is that of maintaining the process temperature under variation of heat losses (by changing the cooling water flow rate).

The actual temperature is measured using resistor thermometer. The temperature signal is suitably amplified to drive 200mv/°c for each one degree change.

The control of the power to the process heater is achieved using the thyristor circuit operating in burst firing mode. The average power to the heater is controlled from 0 to 100% via controlling the root mean square value of the heater voltage from 0 to 220v. Which equivalent to -10 to +10 control signal.

The level process is a continuous process. The apparatus consists of level tank, driving pump and two pneumatic valves, one for feedback water (control value) and the other for output water flow rate discharging (to heater); each one has individual positioning unit. The control problem investigated is that to maintain the tank level constant under variation of output water flow rate. The actual level is measured using level sensor (Piezoelectric sensor). The level signal is suitably amplified to drive 50mv for one percent of the tank capacity (1 cm height). The controller output signal is 0-5 volt to operate the feedback valve through positioning unit (0-5v/0-20psi) and the feeding pump is supplied from constant 220V AC supply. The tank level 1m and diameter 20cm, the total schematic diagram of the processes, thermal and level, is shown in Fig. 8.

The thermal and level models are a small prototype of the Deethanizer of LPG recovery process as shown in Fig.

8, and the analogy between the two processes is summarized in the following points:

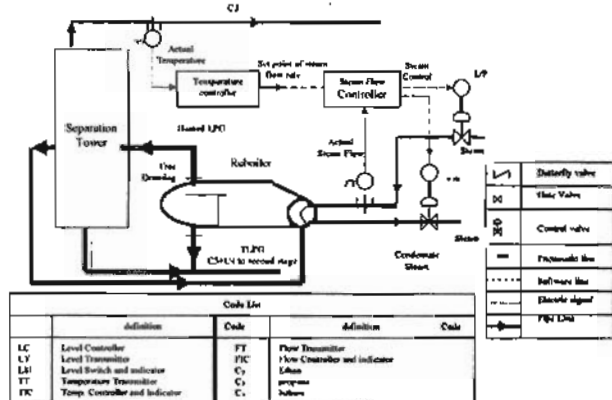

Fig. 7 Schematic diagram of Deethanizer LPG Recovery process

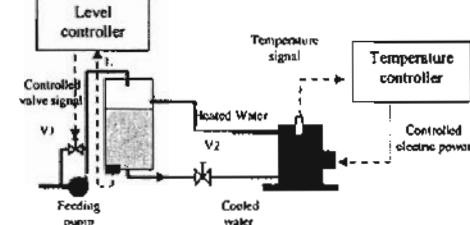

Fig. 8 Schematic diagram of experimental model

- 1-The variation of the steam conditions of the heating system in the actual process is equivalent to the variation of the cooling water flow rate in the process model.
- 2-The control signal in the actual process varies the steam flow rate to change LPG temperature also the control signal in the thermal model changes the average power to the electric heater.
- 3-The controlled variable in the actual process is the outlet Ethan temperature but in the model is the water temperature.
- 4-The variation of the second stage demands conditions in the actual process is equivalent to variation of output water flow rate in the process model.
- 5-The control signal in the actual process varies the feedback flow rate to change LPG level also the control signal in the level model changes the feedback flow rate.
- 6-The controlled variable in the actual process is the LPG level in the process tower but in the model is the water level in the tank.

IV.1 EXPERIMENTAL PROCESS IDENTIFICATION

To obtain the mathematical model of the process, i.e. to identify the process parameters, the process is looked as a black box, with an input step is applied ( 20 °C ), the identified model is given by equation (15) and the open loop time response is shown in Fig. 9.

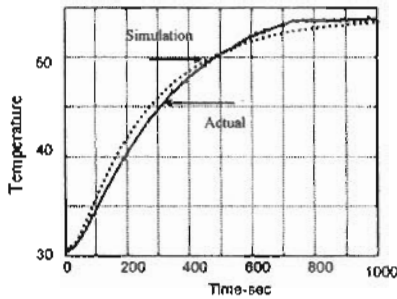

Fig. 9 The actual and simulated time responses of the temperature process.

$$x(k+1) = \begin{bmatrix} -0.04 & 0.0016 \\ 1 & 0 \end{bmatrix} x(k) + \begin{bmatrix} 1 \\ 0 \end{bmatrix} u(k) \quad (15)$$

$$y(k) = [0 \quad 0.0001864] x(k)$$

where  $y \in \mathbb{R}$  represents the output temperature and  $u \in \mathbb{R}$  represents the heater signal. The identified model is approximated as a linear model, but exactly the closed loop system is nonlinear due to the limitation in the control signal ( $\pm 10v$ ). Using the method of PID tuning [13] gives the following tuning parameters:

$$K_p = 60, K_i = 80, \text{ and } K_d = 20.$$

These parameters gave a good response in this case but the main drawback that, if the system exposed to a random disturbance (variable flow rate), the response oscillates as shown in Fig. 10 and PID controller parameters must be returned. Retuning the parameters in the system like LPG is very critical and need a high experience. Therefore, another approach must be introduced to avoid this problem.

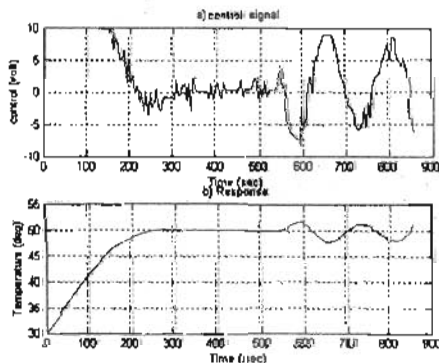

Fig. 10 Tuned PID response with disturbance effect

#### IV.2 IMPLEMENTATION OF ADAPTIVE FUZZY CONTROLLER ON EXPERIMENT CASE STUDY

##### IV.2.1 NORMALIZED FUZZY CONTROLLER

To overcome the problem of PID parameter variation, a normalized Fuzzy controller with adjustable scale factors is suggested. In our experimental case study, the fuzzy controller designed has the membership function as shown in Fig. 2 and the fuzzy controller rule base is shown in Table 1.

Fig. 11 shows the response of the normalized FLC on simulated experimental model with gain values error is 1, rate of error is 1 and control signal is 10. The response has high steady state error.

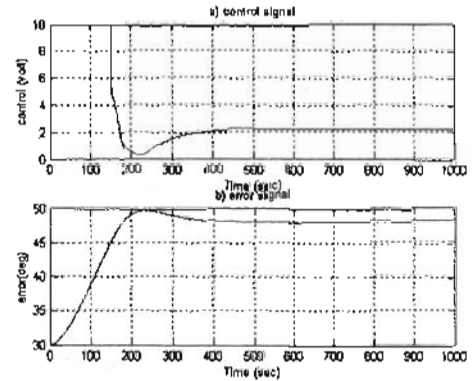

Fig. 11 simulation of normalized FLC

Fig. 12 shows the simulation responses for different values of scale factors selected manually (5-15 error gain, 10-20 rate of error, 6-10v control output signal). We can conclude from the responses of Fig. 12 that, output scale factors has a direct effect on the output response mainly the steady state error, but changing the input scale factors have a less effect on the steady state response but mainly improve the transient response [19].

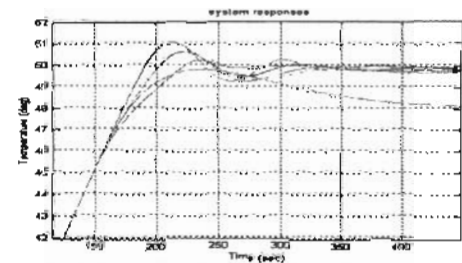

Fig. 12 simulation response for different scale factors

Adjusting the gains according to the simulation results, the system responses for different input/output gains are shown in Fig. 13. From the analysis of the above responses, we can conclude that:

- Decreasing input scale factors increases the response offset.
- Increasing output scale factor fasts the response of the system but may cause some oscillations.

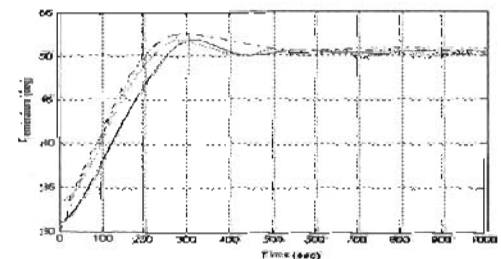

Fig. 13 Actual responses for different input/ output gains

So the selection must compromise between input and output scale factors.

In the following section, the output scale factor is adapted where the input scale factors are fixed at 10 error scale and 15 rate of error scale based on manual tuning result. The introduced two methods, GD adaptation method and supervisor fuzzy, are tested to adapt the output scale factor.

IV.2.2 OUTPUT SCALE FACTOR ADAPTATION USING GD ADAPTATION METHOD

The adaptive variable here is the output scale factor gain (denormalization factor). Therefore, the GD method seeks to decrease the value of the quadratic objective function based on the instantaneous error as shown from equations (1) – (6).

Fig. 14 shows the response of the experimental system when  $\Theta_0=1$  and  $\alpha=0.5$ . Fig. 15 shows the responses for different values of  $\alpha$  (0.1, 0.3, 0.5 and 1). Changing the initial value of scale factor to 10 at  $\alpha$  equal 0.5 gives the response shown in Fig. 16. Also Fig. 17 shows the responses of the system when initial gain 10 and different values of  $\alpha$  (0.1, 0.3, 0.5 and 1). The selection of initial gain and adaptation factor is chosen by trial and error. There is no specific method to determine the optimal value but there is a guide values. For instance, adaptation factor range  $0 < \alpha < 2$  [17] otherwise the response oscillate. Also the initial value should to be  $0 < \Theta_0 < \text{maximum universe of discourse of the control membership function}$ .

It has been noted that, the responses obtained using GD methods is slow compared to the previous responses.

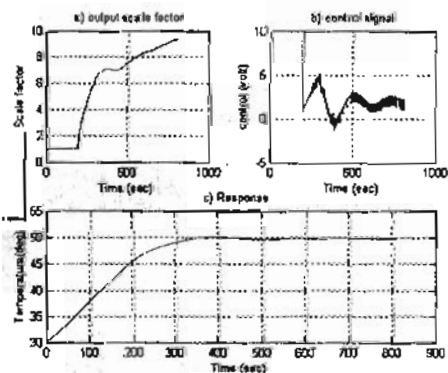

Fig. 14 actual response using GD method in case of  $\alpha=0.5$  and initial gain = 1

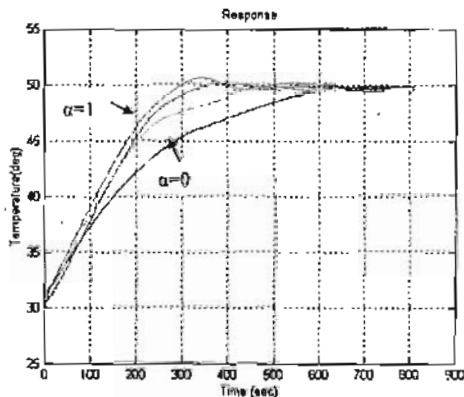

Fig. 15 Different responses for different values of  $\alpha$  at gain = 1

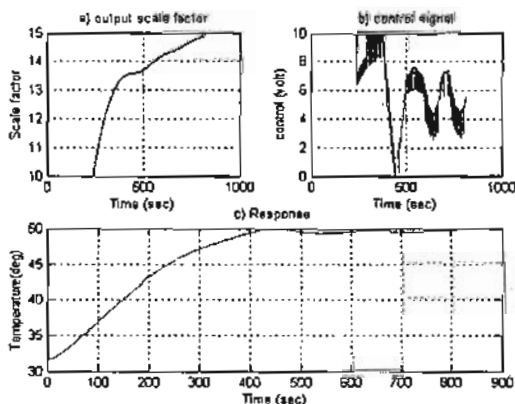

Fig. 16 Actual response using GD method in case of  $\alpha=0.5$  and initial gain = 10

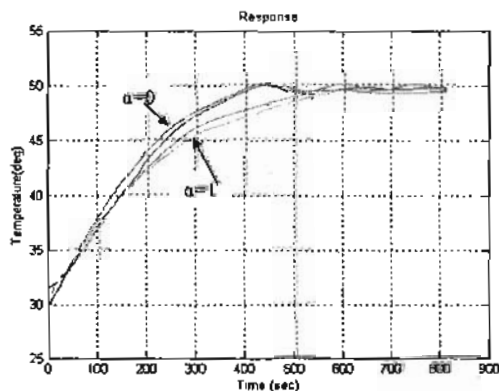

Fig. 17 Different responses for different values of  $\alpha$  at gain = 10

IV.2.3 FUZZY SUPERVISOR ADAPTATION

The overall block diagram of the system with supervisor controller is shown in Fig. 1. Firstly, the output gain is adapted only as in GD method to compare between them. The reference model is taken as a unity gain. The fuzzy supervisory algorithm discussed in section III is



implemented here, where the membership is taken as in Fig. 5 and the range of scale factor of output is  $u_f=2$  and  $u_b=6$  while the input scale is neglected. Fig. 18 shows the system response using supervisory fuzzy controller. Fig. 19 compares between the best responses using GD with supervisor fuzzy response. The two responses are almost similar. The response of supervisor fuzzy is relatively faster.

Checking the robustness of supervisor controller to system disturbance is shown in Fig. 20, where the cooling water flow rate is changed during the system operation which equivalent to steam variation in LPG recovery process. Flow rate can be changed from 0% to 100% where 100% flow rate means 2 liter/min. Tuning both input and output scale factors using supervisor controller, the supervisor fuzzy will be multi-input multi-output fuzzy controller without coupling between the variables, i.e. the same supervisor algorithm is applied to each output individually with different universe of discourses. The scale factor of the error signal is limited by the maximum allowable error according to equation (13).

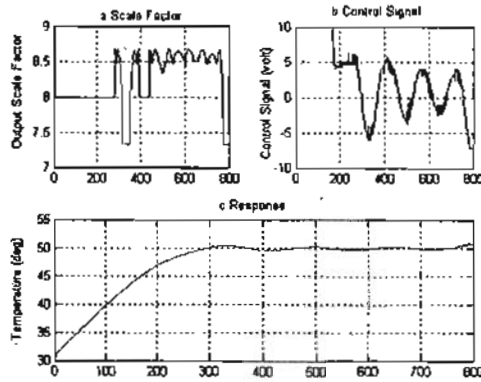

Fig. 18 supervisory fuzzy response

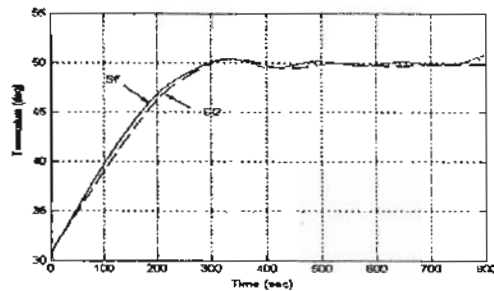

Fig. 19 Responses of GD with supervisor

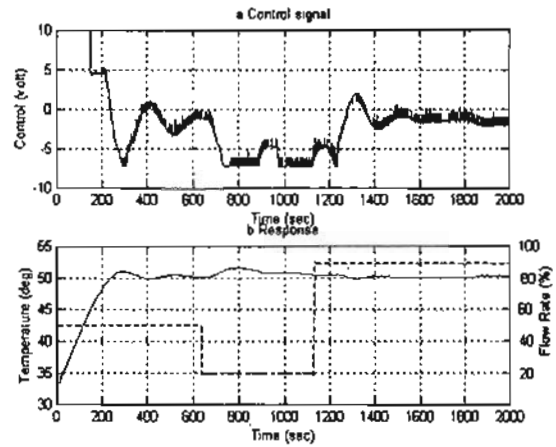

Fig. 20 Actual response using supervisor controller when input gains 15 and 20 and disturbed flow rated

Fig. 21 shows the response of the disturbed system using supervisor controller for input and output scale factors. Fig. 22 shows a comparison between output scale supervision and output/input supervision. It is noted that, input/output supervision reduces the ripple which can be happen.

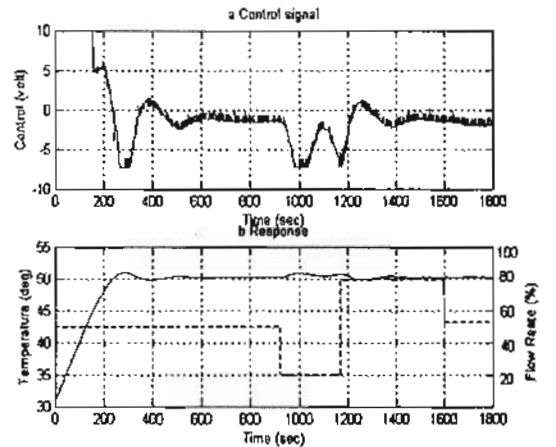

Fig. 21 Actual response using supervisor controller for input and output

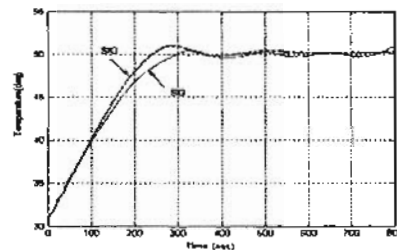

Fig. 22 Comparison between supervisor output and input/output

All the previous results are taken with considering that the reference response is step. In practice, there is no physical system can be changed from initial value to final value in no time. Hence, the required performance is transferred to a reference model and the system should be

forced to follow the required response (overshoot, rise time, etc.). The desired specifications of the system should be: overshoot  $\leq 20\%$ ; rise time  $\leq 150$ sec; based on the experience of the process. The desired discrete state space model that achieves the desired specifications is described by the model shown in equation (16).

$$x(k+1) = \begin{bmatrix} -0.9761 & 0.394 \\ 1 & 0 \end{bmatrix} x(k) + \begin{bmatrix} 1 \\ 0 \end{bmatrix} u(k) \quad (16)$$

$$y(k) = [0 \quad 0.6277] x(k)$$

Fig. 23 shows the system response compared to the desired model response when water flow rate is 50%. Also, Fig. 24 shows the response when flow rate is 80%. Fig. 25 shows a comparison between the two responses.

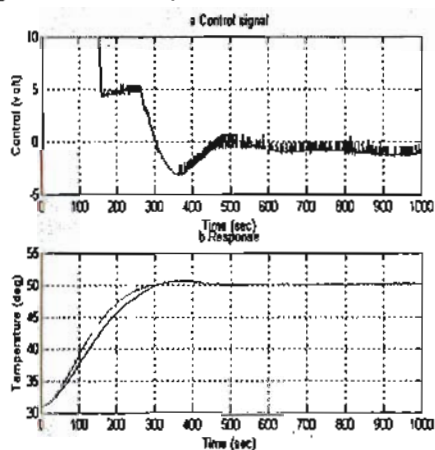

Fig. 23 Actual response using model reference supervisor controller at flow 50%

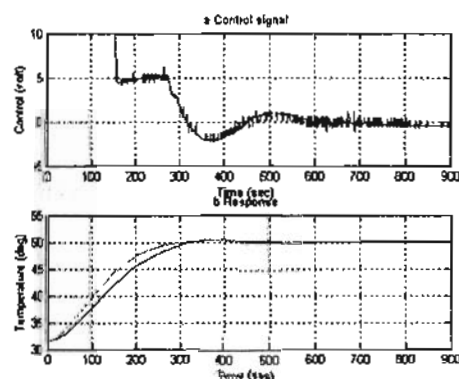

Fig. 24 Actual response using model reference supervisor controller at flow 80%

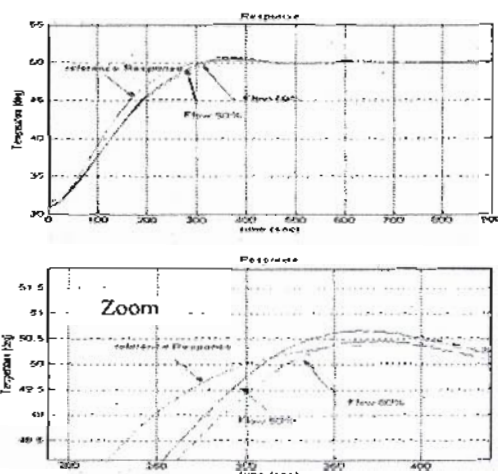

Fig. 25 Comparison between responses at 50% and 80% flow rate

According to the simulation and practical results of temperature loop it can be concluded that:

1- GD methods give a relatively slow response and depend on the initial values of the algorithm parameters. Another drawback of GD method is that, sometimes the adaptation equation is very hard to implement. For instance if we used the GD method to adapt the input scale factor, the equation is not easy to obtain because it depend on the type of fuzzy system used and FIS tools (membership functions type, fuzzy implication method, fuzzy controller type ... etc).

2- The suggested approach (Fuzzy supervision) is easy to built and give a good response. The mathematical tools are very simple. The supervisory algorithm does not dependent on the main fuzzy controller and its parameters (normalized fuzzy and FIS). Also it can be generalized to most of single input/output loops in any DCS as in the next section.

#### IV.3 Implementation of Generalized Algorithm on Level Control loop as a Process variable in LPG Recovery Process

The suggested method to control the temperature is introduced in the previous section. The suggested algorithm will be generalized on the level process variable. The level of LPG in the Deethanizer tower is controlled based on the second stage (Depropanizer and Debutanizer) demand and the utility required as in Fig. 7. Adjusting the output/input scale factors range of the supervisory controller according to equations (11-14) and test the overall system for step input equivalent to 60cm level and the outlet valve adjusted to 50% open. The fuzzy rule base the same as in Table 2 which was used in the thermal process with adjusting the scales of input and outputs according to the algorithm used in course controller. The new membership function of the supervisory controller in this case will be as in Fig. 5

where the range of scale factor is taken as  $e_i=1$ ,  $e_h=10$ ,  $u_i=0v$  and  $u_h=5v$ .

Adjusting the output scale factor range of the supervisory controller according to equation (10) and the same input scale factor ranges used in temperature control and test the overall system for step input equivalent to 60cm level and the outlet value adjusted to 50% open as shown in Fig. 26. The response has 2% steady state error and that is due to the input scales are not adjusted according to the described algorithm in course control mode.

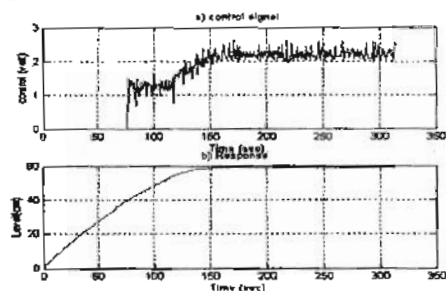

Fig. 26 Level response with adjusted output scale

The system response and scale factor variation, with variable discharging flow rate from 50, 60,50 to 40, are shown in Fig. 27. The results of the level process responses show that the suggested algorithm is suitable to most of process variables in any DCS with small efforts on the main supervision.

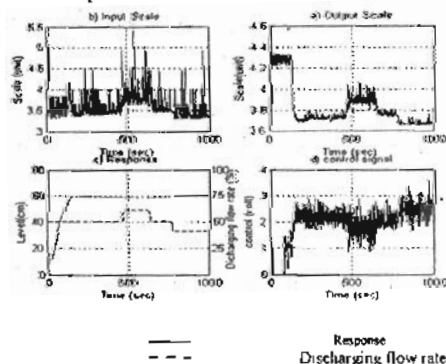

Fig. 27 Level response for step 60 cm and disturbed discharging flow rate

## V. CONCLUSIONS

LPG recovery process is an important subsystem in most of refining petroleum industries. It is a multi-input/output process and PI controller is the main controller used to control the most of process variables. Process is frequently exposed to unexpected conditions and the controller fail to maintain the process variable in satisfied conditions and it is necessary to retune the controller. Supervisory fuzzy controller is suggested here to adapt normalized fuzzy controller, mainly output/input scale factors. The algorithm is tested on an experimental prototype model, which simulates the heating and level control process in LPG unit. Adaptive fuzzy controller is

also adapted using GD adaptation methods on the output scale factor and it gave an acceptable response but it difficult to be applied to the inputs scale factor of the selected fuzzy controller which need a special parameters of fuzzy controller e.g. it needs a differentiable membership functions. Moreover, the response depends on the initial values of adaptation algorithm.

Generalization of the suggested algorithm is achieved by implementation the generalization method on the level loop. Hence it can be applied to any multi-input/output system as multi-loops of single-input/output loop (Decoupling). This method also seems to be simple to implement, systematic, and has a less computational burden. Whatever, this method does not the best but it consider as a primary solution to the system until good system identification is achieved. Hence using the control methods based on the model of the control system will give more accurate response.

## REFERENCES

- [1] Chang-Ching Yu, *Autotuning of PID controller: a relay feedback approach*, 2<sup>nd</sup> ed., Springer, 2006.
- [2] K. Astrom and T. Haggjund, *PID controller. Theory design and Tuning*, 2<sup>nd</sup> edition, instrument society of America, 1995.
- [3] M. Abdel-Gelil and A. Khalil, "Adaptive Fuzzy Controller for Loop Control in a Distributed Control", *Mediterranean control Conference, Greece, June 2009*, pp 55-60.
- [4] L. H. Tsoukvas and R. E. Uhring, *Fuzzy and Neural Approaches in Engineering*, John Wiley Sons, inc., 1997
- [5] H. Hargras, *Applications on Fuzzy Logic Control, Genetic Algorithms in Intelligent process Control*, M. Sc Thesis, Alex. University, 1996.
- [6] C. J. Harris, C. G. Moore and M. Brown, *Intelligent Control Aspects of Fuzzy Logic and Neural Nets*, World Scientific, 1993
- [7] Leonid Reznik, *Fuzzy Controllers*, Newness, 1997.
- [8] Roland S. Burns, *Advanced Control Engineering*, Butterworth-Heinemann, 2001
- [9] Marco Russo Lakhumi C Join, *Fuzzy Learning and Applications*, CRC Press, 2001
- [10] Han-Xiong Li and Shouping Guan, "Hybrid Intelligent Control Strategy", *IEEE Control System Magazine*, pp 36-48, June 2001
- [11] L. X. Wang, *Adaptive Fuzzy System & Control design & Stability Analysis*, Prentice-Hall, 1994.
- [12] Junhang Nie and Derek A. Linkens, *Fuzzy-Neural Control Principle, algorithms and application*, Prentice-Hall Europe, 1995.
- [13] Kal Johan Astrom and Bjorn Wittenmark, *Adaptive control*, Addison-Wesley, 1997.
- [14] Plam R. "Scaling of Fuzzy Controllers Using the Cross-correction", *IEEE Transaction on Fuzzy Systems*, vol 3 no1, pp 116-130, 1995.
- [15] R. R. Yager and D. P. Filer, *Essentials of Fuzzy Modeling and Control*, John Wiley, 1994.
- [16] Renzik L. and Stoica A., "Some Tricks in Fuzzy Controller design", *In: Proceedings of Australia and new Zealand Conference on Intelligent information systems, ANZIS-93*, IEEE, Perth, Western Australia, pp. 60-64, 1993.
- [17] Kovacic Z., Cupur R. and Bogdan S., "A Servo Positioning by using Model Reference Adaptive Fuzzy controller", *Proc. IFAC 2001*.
- [18] "The Control Handbook", IEEE press, CRC 1996, P.P 994-1017.
- [19] J. M. Mendel, "Fuzzy Logic Systems for Engineering A tutorial", *Proc. IEEE*, vol. 83, pp.345-377, 1995