

DEVELOPMENT OF SOLAR CELLS ARRAY PERFORMANCE COUPLED WITH DC CHOPPER

Nour H. M.***

Energy and Power Dept., Agric. Eng. Res. Inst., ARC. Dokki, Giza .

ABSTRACT

The aim of this search is the determination of electrical performance of photovoltaic power system connected with a predesigned DC chopper (DCC), which is built in the solar energy laboratory of our electrical department. Mathematical model is built up to define the system operation. Optimum limits of chopping frequency are determined. The effect of load (DC Fan) and insolation level change upon the performance of solar cells array (SCA) are investigated. In the present paper, a novel circuit, referred to as the generation control circuit (GCC), or DC chopper which enables maximum power to be obtained from all of the PV modules even if some of the modules are prevented from receiving light. The proposed circuit enables the individual PV modules to operate effectively at the maximum power irrespective of the series connected PV module system.

Keywords: Microcontroller , photovoltaic , DC chopper (DCC) .

INTRODUCTION

Photovoltaic energy seems to become one of the most important renewable energy resources in the near future, since it is clean, pollution free, and inexhaustible. Due to the rapid growth in semiconductors and power electronic techniques, the solar energy is of increasing interest in electrical power applications, and a large research activity has been carried out in this field over the last years.

Application of solar power drive is certainly growing as they offer clean source of energy and also there is need to conserve fossil fuels. At present solar drives are employed for space applications and water pumping particularly for agriculture applications and is seriously contender for use in room air conditioners. Standard DC motors are mostly used as constant speed or adjustable speed motors. The control schemes employed for the same are developing day by day for reliable operation various sources of electrical energy are employed along with the drive. The power control scheme uses semiconductor devices such as MOSFET, IGBT, etc. with various switching techniques. The designers are forced to optimization of the performance of solar power DC motor drives. These drives have now dominated the area of variable speed because of their low cost reliability and simple control [Moleykutty G, 2012].

The solar energy i.e. heat energy is converted to electrical energy (in DC voltage) using photovoltaic cell. In absence of solar energy, the power can also be supplied from batteries, rectifier or DC generator. The voltage needs to be step up using Boost Converter. Hence Boost converters are called as step up converter. The variable DC voltage can be achieved by using chopper. This variable DC voltage is required for the control of Drives with adjustable or varying speed control. The complete system of equivalent solar

energy PV model feeding DC drives through control technique is as shown below. Some Application require the use of DC Drive, such as space application, water pumping, etc, Now, a day application of solar power is increasing as to conserve the energy [Rajesh and Ramersh 2014].

The quality of load matching is defined by two factors: the insolation-utilization efficiency, and the time-utilization efficiency, both are defined by the ratio of load input power to the maximum available power of the PV array for a given insolation level and time. Optimum matching of loads to the photovoltaic generator is most desirable for more accurate sizing higher system performance and maximum utilization of cost solar array generator. The quality of load matching depends on the PV array characteristic, the load characteristic and the insolation profile. Matching factor is defined as the ratio of load energy to the array maximum energy over one day period. Optimum matching is achieved by determining the optimal array parameters with respect to the load parameters. Optimization is carried out by using direct search techniques as shown in reference [Kamel .K. 2011]. The dc to dc converter connected to a motor load fed by a photovoltaic cell is carried. This is an efficient way of utilizing the non renewable energy resources for domestic appliances where there is no availability of power supply.

The use of the bidirectional dc to dc to converter is advantageous as it enhances the signal and helps in boosting the voltage obtained from the output of the photovoltaic array. The output of the PV array is a low voltage which can be boosted up to a required level using the converter. This is the great advantage of this project as the appliances can be run with less number of solar cells. This work can be extended to even ac motors by introducing an inverter circuit at the load side. Hence this can be best option at the remote places where there is no way to transmit the power. [International Journal, 2014].

The DC motor is considered as a SISO (Single Input and Single Output) system which has torque/speed characteristics and is compatible with most mechanical loads. By proper adjustment of the terminal voltage [Dubey. G.K ,2013] the mentioned characteristic makes a D.C motor controllable over a wide range of speeds. In this article controlling DC motor speed using Chopper as power converter and PI as speed and current controller is investigated. A chopper is a static power electronic device that converts fixed dc input voltage to a variable dc output voltage. Chopper systems have smooth control capability and are highly efficient and fast in response. A chopper can be used to step down or step up the fixed dc input voltage [Bimbhra , P.S. 2008] like a transformer.

In the another study based on closed loop system model and using chopper as a converter and Proportional-Integral type Speed and Current controller the speed of a dc motor has been controlled. At first for controlling speed of DC motor a simplified closed loop is utilized and requirement of current controller is studied. After that DC motor is modeled more completely and a full layout of DC drive system is achieved. A current and speed controller is designed. The speed control loop is optimized through Modulus

Hugging approach. A DC motor specification is taken and corresponding parameters are driven from derived design approach. [Gopakumar,2013].

In this paper an efficient attempt is made for using the non-renewable energy resource (solar energy) as an voltage source input i.e. the output voltage of the photovoltaic array is used as an input to run the load. In this paper the load and the source are separated by a dc-dc chopper. The mono-crystalline model of the PV array connected to dc motor separated by a dc – dc chopper is developed and the outputs are presented. The block diagram shown below gives a basic idea of the paper.

The dc chopper plays an important role of matching the load with solar cells array (SCA). The (DCC) regulating the (SCA) terminal voltage and tracks it at maximum power output. The technique of changing frequency is used to achieve the previous aim..

MATERIALS AND METHODS

Photovoltaic Effect:

Photovoltaic (PV) is a method of generating electrical power by converting solar radiation into direct current electricity using semiconductors that exhibit the photovoltaic effect. Photovoltaic power generation employs solar panels comprising a number of cells containing a photovoltaic material. Materials presently used for photovoltaic include mono crystalline silicon, polycrystalline silicon, amorphous silicon, cadmium telluride, and copper indium selenide/sulfide. Due to the growing demand for renewable energy sources, the manufacturing of solar cells and photovoltaic arrays has advanced considerably in recent years.

Solar Cell:

A solar cell is a solid state device that converts the energy of sunlight directly into electricity by the photovoltaic effect. Assemblies of cells are used to make solar modules, also known as solar panels. The energy generated from these solar modules, referred to as solar power, is an example of solar energy..Fig (1) shows the photo of the solar cells array, and table ,(1) illustrates its specifications, and the electrical specifications were listed in Table.(2).



Figure (1) : The photo of the mono-crystalline PV.

Table (1): The specifications of the photovoltaic module.

Cell Technology	Specifications
Panel dimensions (m x m)	1.20 x .0.53
Front cover (glass) ,mm	6
Cell dimensions (mm)	120 x 120
Number of cells (in series)	36
Cell Area (m ²)	0.014
Aperture Area (m ²)	0.64
Coverage Area (m ²)	0.61

Table (2): Electrical characteristics of the photovoltaic:

Electrical Characteristics	Specifications
Voltage at peak power (V _{pp})	24
Current at peak power (I _{pp})	5
Open circuit voltage (V _{oc})	26
Short circuit current (I _{sc})	6

Electric Fan:

The proposed DC chopper can be used in agricultural machinery rotation, and In this research a fan of the type DC was used. The electric fan with DC motor was evaluated using the DC chopper designed at laboratory. The photo of the examined DC fan during laboratory experiments are shown in figures (2) .



Figure (2) : DC electric fan

An electric fan driven by DC motor was used as a load during this study, to measure current at peak power and voltage in order to evaluate the performance of the PV output with DC chopper. The specifications of the electric fan are shown in Table (3).

Table (3): The specifications of the electric fan.

Characteristics	Specifications
Fan diameter (mm) :	310
Frame diameter (mm x mm)	350 x 390
Number of blades :	5
<u>Test range :</u>	
Voltage at maximum r.p.m :	10.40
Current at maximum r.p.m :	4.79
Power consumption :	49.82
Operating Temperature (°C)	25 C°
Weight :	4 kg

DC chopper:

DC chopper is a static power electronic device that converts fixed dc input voltage to a variable dc output voltage. A Chopper may be considered as dc equivalent of an (DC) transformer since they behave in an identical manner. Chopper involves one stage conversion; these are more efficient Chopper systems offer smooth control, high efficiency. A chopper is a high speed on or off semiconductor switch. It connects source to load and disconnect the load (DC fan) from source (PV modules) at a fast speed . The Schematic diagram of the DC chopper circuit is shown in fig.(3).

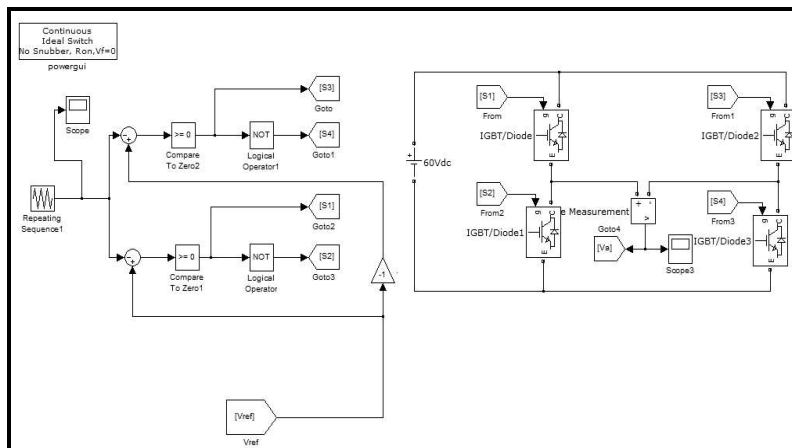

Fig (3) : The Schematic diagram of the DC chopper circuit.

Experimental System under Test and the results For obtaining the electrical characteristic of solar cells array, the experimental system shown in Fig.(4) is built up. This system contains one module of (SCA) (with specifications 120 watt maximum output power, 24 volt open circuit voltage (DC) chopper (DCC), which is designed in our laboratory, and variable static resistive load [Agricultural DC Motors Load (DC cooling fan)]. The design procedures of the chopper are shown in figure (4).

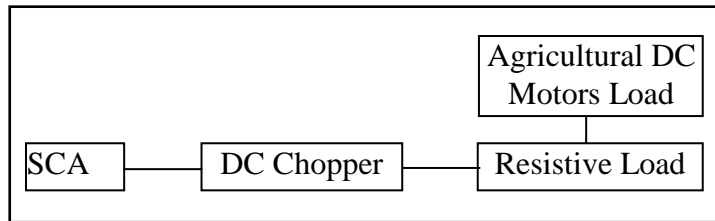

Fig.. (4) : Blok diagram of the experimental system.

RESULTS AND DISCUSSION

The aim for obtaining the previous characteristics is the determination of the optimum frequencies required to operate the load continuously at maximum power point at different insulation levels. To achieve the later goal, the electrical characteristics of (SCA) directly connected with the load are recorded at different insulation levels. Then, the locus of maximum power points curve is obtained. Fig.(5) illustrates these characteristics and the locus of the maximum power points of the module under test. On the other hand, the electrical characteristics of (SCA) under test connected with the same load through (DCC) are also recorded at different insulation levels and chopping frequencies.

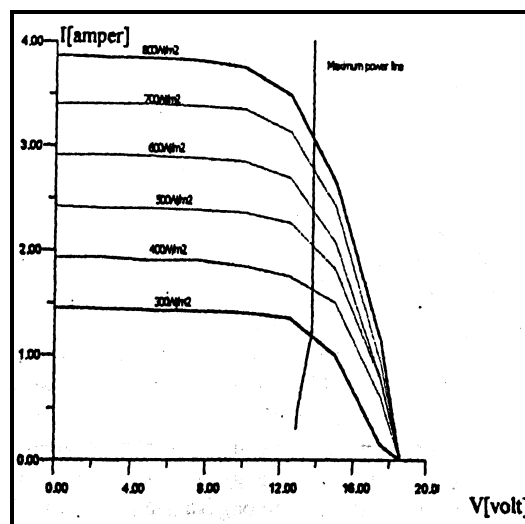

Fig. (5) : Characteristics of SCA under test and the locus of maximum power point at different insulation levels without coupling with DDC.

Fig.(5) shows the sample of these measurements. In this figure the (I-V) characteristic of (SCA) without connection of (DCC) is known as the extreme characteristic. The optimum load (load at maximum power point) for the

extreme characteristic is also shown in the figure by the extreme load line (Lo). Other arbitrary loads are also shown in the figure. These loads don't operate at maximum power point of the extreme characteristic. The problem is how to operate these loads at voltage of maximum power point (to regulate the load voltage) of the extreme characteristic. At this instant the role of (DCC) becomes very important. The (DCC) is employed to operate these arbitrary loads at voltage of maximum power point of the extreme characteristic by changing its chopping frequency. The figure shows also that the electrical characteristics of SCA at different chopping frequencies (the insulation level is constant) (C.F) go down the extreme characteristic and the arbitrary loads become the optimum ones for these characteristics.

Fig.(6) represents that the voltages at maximum power point for all characteristics become fixed. Various behaviors of SCA are obtained from the previous figure.

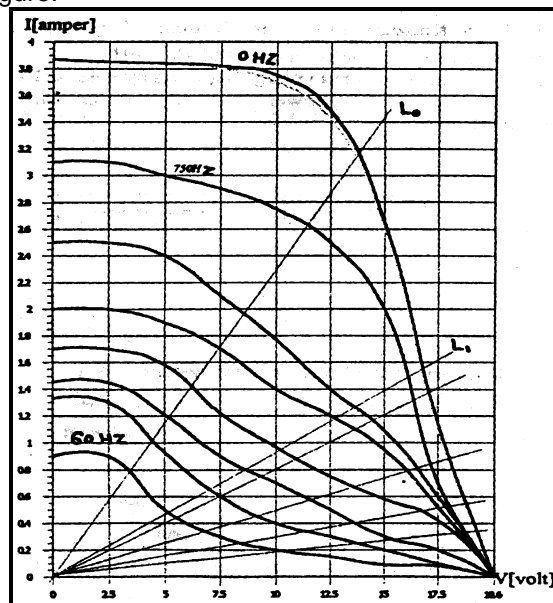

Fig.(6) : I -V Characteristics of SCA at the instant of Employing DCC at Different chopping Frequencies and Fixed Insulation Level of 800 W/m.

The relationship between the voltage deviation (VD) and chopping frequency at different insulation levels is illustrated in Fig (7). The voltage deviation (VD) is formed as,

$$VD = V_{Loe} - V_{mp} \dots\dots\dots (1)$$

Where;

V_{mp} : is the voltage at maximum power point of the extreme characteristic at specific insulation level and

V_{loe} : is the voltage corresponding to the intersection of load line with chopping characteristic (the characteristic of (SCA) connected with IXC at the same insulation level of the extreme characteristics).

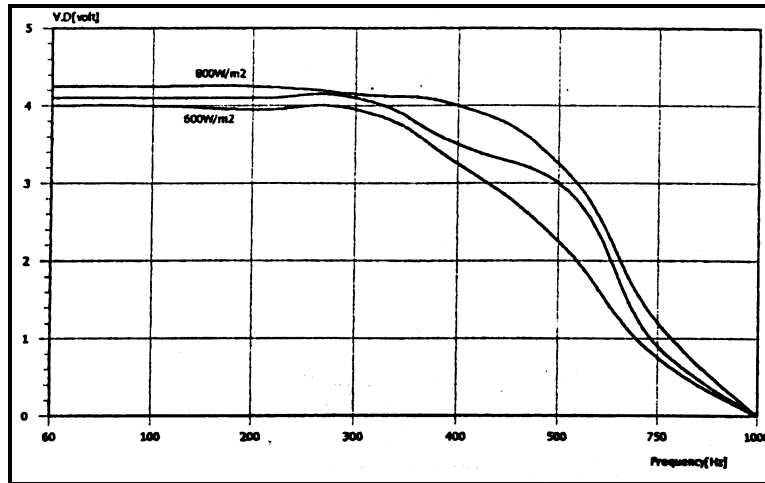

Fig.(7) : Relationships between Voltage Deviation VD and chopping frequencies at Different Insulation levels.

This figure represents that for all insulation levels vd decreases as the frequency increases. But, the rate of change of (VD) is very low in the frequency range of $60 < F_{ch} < 400$ Hz. Conversely, the previous change becomes very high during the range of $400 < F_{ch} < 1000$ Hz. This is due the fact that the first range of the chopping frequency (C.F) provides suitable frequencies for high loads. On the other hand, the second range represents suitable chopping frequencies for low loads near to the maximum power point of the extreme characteristic. The dc chopper frequency range suitable for the module under test is $60 < F_{ch} < 1000$ Hz. The high level of (C.F) (1000 Hz) is the extreme frequency above which the (DCC) loses its role of operation with SCA and doesn't operate. The low level of (C.F) (60Hz) represents the minimum value of (C.F) corresponding to a very high load level. At this load the SCA must not operate, because the extracted power of SCA becomes very small.

The relationship between the ratio of the load at maximum power points of chopping characteristics and that of the extreme characteristic which is called as load ratio (U) against frequency is illustrated in Fig.(8).

$$L_r = \frac{L_n}{L_o} \dots\dots\dots (2)$$

Where;

L_n : is the arbitrary load in ohm,

L_o :is the optimum load located at maximum power point (MPP)of the extreme characteristic.

The figure represents the inverse relation between (L) and (C.F). The effect of insulation level upon the tested module is also illustrated in this figure. At

high insulation level, large values of load ratios are obtained conversely, small values of (L) are achieved at low insulation level. This means that, the chopper loses its role at low levels of insulations. In essence, there are two limits control the (DCC) operation. The first one is C.F and the other becomes insulation level.

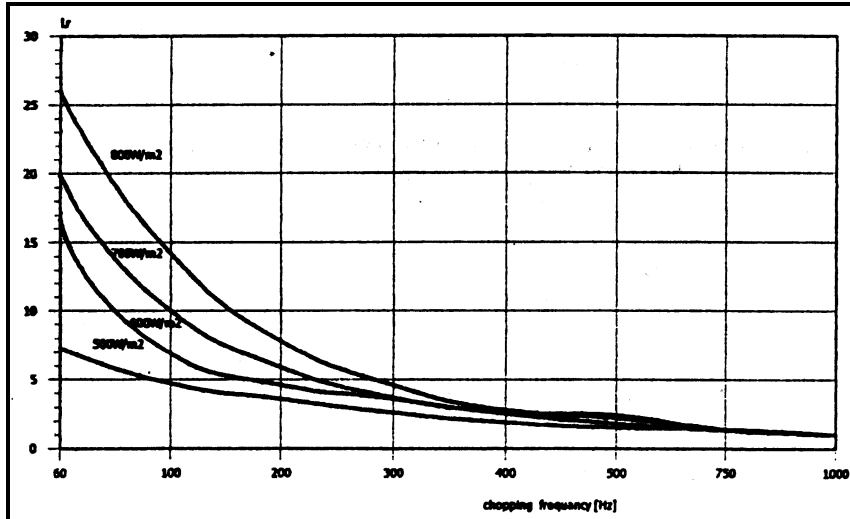

Fig.(8) : The Load ratio L against Chopping Frequency at Different Levels of Insulation.

Fig.8 is modeled mathematically for giving required C.F at any level of insulation and any load ratio. This relation is modeled as;

$$f_{ch} = \frac{L_n(L_r)}{8 * 10^{-5} * I_n} \quad (\text{Hz}) \dots\dots\dots (3)$$

Where,

I_n : is insulation level , W/m².

Fig.(9). shows the relation between specific load terminal voltage and insulation level at different C.F. (the load is fixed constant during the measurements). The figure represents that, the linear part of the characteristics are obtained at C.F range of 0<Fdl<400 HZ. But at the range 4<XKFcfa<800 HZ the load terminal voltage becomes constant at values rather than that at maximum power points.

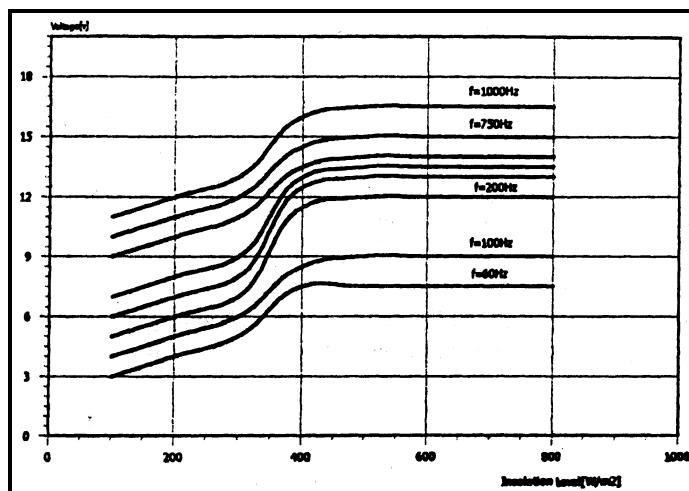

Fig.(9) : Relation between Specific Load terminal Voltage and Insulation level at Different Chopping Frequencies.

CONCLUSIONS

In this paper the technique of varying the solar cells array terminal voltage by using a predesigned DC chopper, which designed at solar energy laboratory of electrical engineering department, The chopper used for fixing the array terminal voltage at specific value and tracking the point of maximum power of (SCA). The best value of voltage at which the array terminal voltage must be fixed is the voltage at maximum power point of the (SCA) characteristics without using (DCC). The (DCC) employs for fixing the array terminal voltage at pervious specific value. The electrical performance of the photovoltaic system operates with and without DC chopper is investigated. The results show that, there exist lower and upper levels of chopping frequencies between them the best operation of the system which contains dc chopper is obtained. The frequency range of operation depends upon the number of modules used. An important mathematical model is built up for determining the optimum chopping frequency at which the DC chopper operates at specific load and insulation level. The results show that the insulation levels and load ratios having significant effect upon the PV system operates with (DCC). The chopper used here has an efficiency of about 93 percent.

REFERENCES

- Bimbhra, P.S., Power Electronics. New Delhi, Khanna Publishers, 2008.
- Dubey, G.K., Fundamentals of Electrical Drives. New Delhi, Narosa Publishing House 2013
- Gopakumar, K., " Power Electronics and Electrical Drives", Video Lectures 1-25, Centre for Electronics and Technology, Indian Institute of Science, Bangalore 2013.
- International Journal of Advanced Research in Electrical Electronics and Instrumentation Engineering (An ISO 3297:2007 Certified Organization) V.3, Issue 12. December 2014.
- Kamel Khouzam., Lucy Khozam and Peter Groumpos "Optimum matching of ohmic loads to the photovoltaic array" solar energy vol.46, 2011 .
- Moleykutty George, Speed Control of Separately Excited DC Motor, American Journal of Applied Sciences, pp. 227-233, 2012.
- Rajesh Sekhera. N.V.V. and A. Ramersh 2014 " IMPROVEMENT IN PV SYSTEM WITH BOOST CONVERTER FED H - BRIDGE INVERTER" . International Conference on Electrical Electronics and Communications-ICEEC-21st June 2014--ISBN-978-93-81693-66-03.

تحسين اداء الخلايا الشمسية المرتبطة مع مقطع جهد مستمر

حمدي محمد نور

قسم بحوث القوى والطاقة – معهد بحوث الهندسة الزراعية- دقى- جيزة

لاشك ان الآلات الزراعية يتم ادارتها من خلال محركات ميكانيكية او جرارات زراعية . ولما كانت هذه القوى المحركة تحتاج الى وقود وزيت واصلح وصيانة ، الامر الذى يؤدي الى عدم تشغيل الآلات الزراعية بطريقة سليمة بثبات او باستمرار و لما كان ايضا استخدام هذه المحركات لم يؤدي الى الحصول على سرعات ثابتة لتشغيل الآلات الزراعية طبقا لتعليمات التشغيل . وفى محاولة جادة لاحتلال المحركات الميكانيكية بمحركات كهربية تعمل بنظام التيار المستمر وتأخذ حركتها من الطاقة الناتجة من الخلايا الشمسية نتيجة تعرضها للضوء من الطاقة الشمسية طوال ساعات النهار والعمل على تثبيت السرعة المطلوبة لئلا من خلال تصميم جهاز الكترونى . لذلك فان البحث له هدف من هذه التقنية الجديدة .

الهدف من البحث :

تصميم جهاز الكترونى للتحكم فى سرعة دوران المحركات الكهربائية والتي تدير الآلات الزراعية والتي تعمل نهارا والتي تستمد طاقاتها الكهربائية من الخلايا الشمسية مباشرة ، بحيث يمكن تشغيل الاحمال بالسرعة المطلوبة ، وتثبيت عدد لفات الآلة بالرغم من تغير شدة الاشعاع الشمسى ، حيث يتم تثبيت سرعة الآلة طوال النهار طبقا لسرعة التشغيل المطلوبة . وهذا الاسلوب التقنى الجديد يهدف الى التحكم فى سرعة دوران الأجزاء الدوارة فى الآلات الزراعية المرتبطة بالهندسة الزراعية والموصلة بمحركات كهربائية تعمل بنظام التيار المستمر (DC) والمغذاه كهربيا من منظومات خلايا شمسية مباشرة حيث تقوم الدوائر الالكترونية بالجهاز المصمم بتثبيت سرعة دوران الآلة بالرغم من عدم انتظام شدة الاشعاع الشمسى طوال النهار .

وفي هذا البحث تم استخدام معدل تغيير التردد كأسلوب تقنى للتحكم فى خرج الخلايا الشمسية وبالتالي التحكم فى سرعة دوران الآلات الزراعية الموصلة بها عن طريق محركات التيار المستمر . ويتم تغيير التردد عن طريق تصميم مقطع الجهد المستمر باستخدام مفاتيح قوى الكترونية يتم التحكم فيها بتصميم دوائر الإشعاع لها يتم عن طريقها تغيير تردد التقطيع

(ON- OFF) وبالتالي يتم تغيير سرعة دوران الآلات الزراعية ويتم التحكم فيها عند مستويات الإشعاع المختلفة طبقا للسرعة المطلوبة
وفي هذا البحث تم تغيير مستويات الإشعاع من ٢٠٠ واط / متر مربع إلي ٨٠٠ واط / متر مربع وهذا هو أقصى إشعاع شمسي تم الحصول عليه في موقع مدينة المنصورة .
ان الإنخفاض عن مستوى الإشعاع الشمسي أقل من ٢٠٠ واط / متر المربع فهذا يعتبر مستوى إشعاع ضعيف لا يفضل استخدام تشغيل الآلات الزراعية عند هذا المستوى . حيث أن هذا المستوى من الإشعاع لا يناسب إدارة الآلات لانخفاض مستوى الجهد الناتج من الخلايا(عادة يكون هذا الإشعاع الشمسي ٢٠٠ واط/م عند الغروب وعادة ما يكون عند انتهاء يوم العمل) .
الغرض من هذا البحث :

الغرض من هذا البحث هو معرفة الأداء الكهربائي لنظام قوى فوتوفولتي موصل مع مقطع جهد مستمر تم تصميمه في معمل الطاقة الشمسية . وقد تمت هذه الدراسة عمليا بالمعمل وتم معرفة الأداء الكهربائي للنظام عمليا . ثم بعد ذلك تم عمل نموذج رياضي هام يوضح أداء نظام الفوتوفولتي . ولقد تم عمليا معرفة الحد الأقصى لقيمة تردد التقطع حيث وجد عمليا أنه إذا زاد هذا التردد عن القيمة القصوى فإن خرج النظام لا يتأثر بتشغيل المقطع . هذا وقد تم معرفة تأثير تغيير الحمل وكذلك أيضا مستوى الإشعاع الشمسي علي أداء النظام ككل .
في هذا البحث تم تصميم مقطع للجهد الناتج (الخارج) من منظومة خلايا شمسية من أجل التحكم في خرجها (I – V)

إن استخدام مقطع الجهد يؤدي إلي تغيير القيمة المتوسطة (Average) للجهد المستمر (DC) الخارج من الخلايا الشمسية وقد تم تغيير تردد التقطع (chopping frequency) من القيمة العظمى التي عندها يكون تردد التقطع النهائي إلي القيم الدنيا ، وقد تم تحديد هذه القيمة عند مستوى ٦٠ هرتز (60 Hertz) لأداء منظومة الخلايا الشمسية (I.V) ، وقد تم تغيير مستوى الإشعاع الشمسي ليصل إلي ٩٠٠ واط /متر مربع، وقد تم تحديد أداء الخلايا عمليا عند فترات مستويات الإشعاع المختلفة مع ترددات تقطع مختلفة. ويمكن استخدام هذه النتائج العملية للتحكم في سرعة دوران آلات الهندسة الزراعية المختلفة (الأجزاء الدورانية في آلات الدارس) مستخدما هذا الأسلوب التقني الجديد للتحكم المباشر في سرعة دوران الأجزاء لآلات الهندسة الزراعية الموصلة بمحركات كهربائية يتم تغذيتها مباشرة من منظومات خلايا شمسية طوال النهار أثناء فترة الإشعاع الشمسي . وفي هذا البحث تم استخدام مروحة هواء تعمل بالتيار المستمر (DC) والتي تستخدم على نطاق واسع في مجال الهندسة الزراعية في التهوية والتبريد بغرض ازالة الحرارة كما هو متبع في تهوية عنابر الدواجن ومزارع الانتاج الحيواني والبيوت المحمية (الصوب الزراعية) ومن خلال استخدام مقطع الجهد يمكن التحكم في عدد لفات المروحة طبقا لتعليمات التشغيل المطلوبة.