

INITIAL TENSION VARIATION DURING UNWINDING OF
KNITTING YARN FROM PACKAGES

By

Shahin, A. and El-Gaiar, M.N.**

* Lecturer at the Textile Eng. Dept., Faculty of Eng.,
Mansoura University, Egypt.** Assoc.Prof. at the Textile Eng. Dept., Faculty of Eng.,
Mansoura University, Egypt.

(Received Feb. 28, 1987, accepted June 1987)

الخلاصة - في هذا البحث تم اختبار تأثير كل من سرعة سحب الخيط وقطر عبوة الخيط على
قيمة الشد أثناء الفك من البكرة بسرعة مساوية لسرعة سحب الخيط على ماكينة التريكو.

بالإضافة الى ذلك تم عمل موديل رياضي يربط العلاقة بين زاوية ميل الخيط على سطح
الكونة بالنسبة للمستوى الافقى مع قيمة الشد في الخيط.

LIST OF SYMBOLS

T_0	tension in yarn before unwinding (cN)
T	yarn tension (cN)
N	normal reaction force between yarn and package surface (cN)
F	friction force between yarn and package surface (cN)
μ	coefficient of friction between yarn and package surface
r	package radius (cm)
H	package stroke (cm)
α	angle of winding (degrees)
φ	angle of inclination of the yarn element between the package surface and the horizontal axis (degrees).
S	unwound yarn length on package surface (cm)
V	yarn withdrawing speed (m/min)
C	integration constant.

ABSTRACT- The object from this work was to measure the yarn tension during unwinding from cylindrical package with a winding speed equivalent to the withdrawing speed for the knitting machine. The value of yarn tension was measured under the effect of the following parameters:

- Yarn withdrawing speed (50, 100 and 200 m/min).
- Package diameter (64, 112 and 148 mm).
- Using brake (brake for a flat knitting machine).

A theoretical model for the behaviour of yarn tension during yarn slippage on the package surface was derived, and the effect of the slope of the contact line between yarn and package surface on the value of yarn tension was calculated.

Experimentally it was found that without using yarn brake by increasing the withdrawal speed up to 100 m/min the yarn tension decreased and increased again by increasing the speed to 200 m/min, and with using yarn brake the yarn tension decreased with increasing the withdrawal speed from 50 to 200 m/min.

1. INTRODUCTION

The variation in yarn tension during knitting process has its influence on many things such as loop geometry, shade variation, or fabric appearance, and stitch density, also power consumption of the machine/6/. The available literature on weft knitting shows that the problem of tension variation during unwinding from packages has not been examined in details. The only available study of tension was examined by Knapp and others in the knitting zone /1,2 and 3/.

Also it is evident from the literature that nothing is mentioned about the optimum dimensions of the package. Although from the economical point of view the larger the dimensions of the package the more will be the saving of doffing and replacement of the package, and hence increasing the efficiency of the machine. But the draw-back of this will be the control of yarn tension during the unwinding operation and at the same time the practical problems associated with handling of large packages. From the practical point of view, it was found that large packages create problems such as sloughing off yarn during unwinding, which would be considered as waste.

By withdrawing the yarn at low speeds the main value of yarn tension is due to friction between yarn and package surface (yarn to yarn friction), and with increasing the withdrawal speed (more than 100 m/min) the main value of yarn tension may be due to balloon rotation.

The value of yarn tension during unwinding from the package fluctuates between maximum and minimum consistent with the position of unwinding point on the package and these values are affected by package characteristic, yarn type and yarn withdrawal speed.

In this experimental work the effect of yarn speed and package diameter on the value of yarn tension have been examined.

2. Mathematical Models

In this theoretical model the extreme case for the value of yarn tension was considered by assuming the following conditions:

- The yarn slips on the package surface from package base to the top.
- The angle of winding at the base of the package is zero, and the direction of friction force as shown in Fig.(1.c).
- The balancing of the forces on the yarn was considered at the beginning of yarn movements because the coefficient of friction between yarn and package surface is high at the beginning of yarn movement, Fig. (2) shows the behaviour of yarn tension due to yarn movement on the package surface from the still position up to withdrawing the yarn with constant speed.

By considering a package with a cylindrical shape as shown in Fig.(1.a), the forces which are on the yarn element Δs as follows:

- yarn tension as in Fig.(1.b)
- yarn tension = $\bar{T}(s + \Delta s) - \bar{T}(s)$
- from Taylor series

$$\bar{T}(s + \Delta s) - \bar{T}(s) \approx \frac{d}{ds} (\bar{T})$$

- friction force as in Fig.(1.b)
friction force = μN
- reaction force
the reaction force N is normal to package surface.

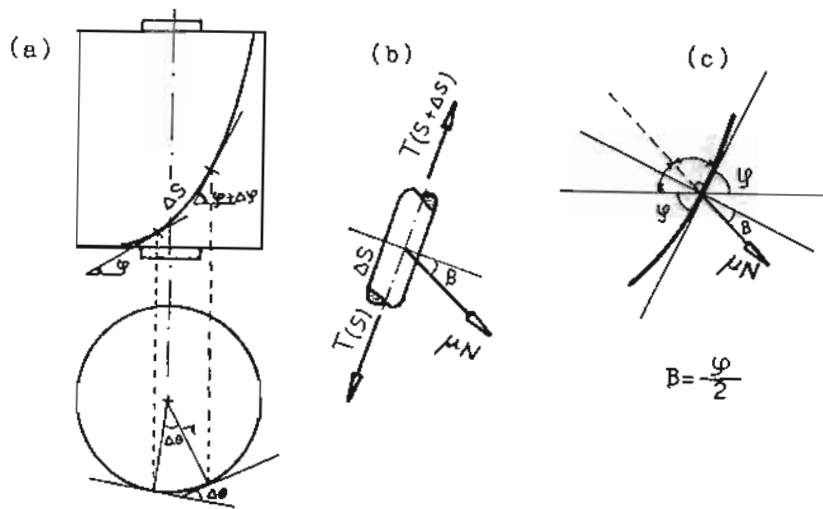

Fig. 1: force analysis on yarn element.

- A- Value of yarn tension at beginning the yarn movement.
- B- Value of yarn tension by withdrawing the yarn with constant speed.

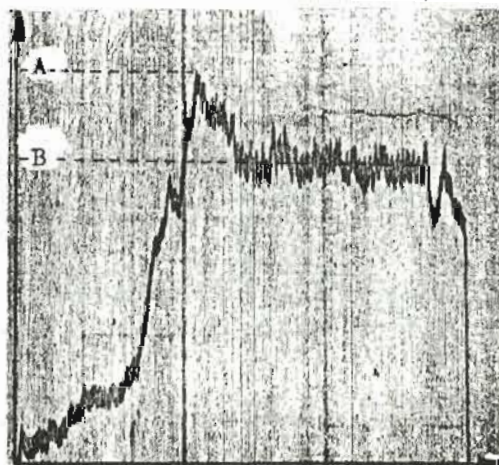

Fig. 2: Behaviour of yarn tension.

By analysing these forces in three directions; tangential to the element, normal to the element and perpendicular to the package surface and for $\sin d\theta = \sin d\psi \approx 0$, $\cos d\theta = \cos d\psi \approx 1$ and for unit length it was found that:

- in the tangential direction:-

$$\frac{d}{ds} (T \cos d\varphi) = \mu N \sin B$$

$$\text{and } \frac{dT}{ds} = \mu N \sin B \quad \dots\dots(1)$$

- in the normal direction:

$$\frac{d}{ds} (T \sin d\varphi) = \mu N \cos B$$

$$\text{and } T \cdot \frac{d\varphi}{ds} = \mu N \cos B \quad \dots\dots(2)$$

- in perpendicular direction:

$$\frac{d}{ds} (T \cos\varphi \sin d\theta) = N$$

$$\text{and } \frac{T}{r} \cos^2\varphi = N \quad \dots\dots(3)$$

from equations (1) and (3)

$$\frac{dT}{ds} = \mu \frac{T}{r} \cos^2\varphi \sin \frac{\varphi}{2} \quad \dots\dots(4)$$

from equations (2) and (3)

$$T \frac{d\varphi}{ds} = \mu \frac{T}{r} \cos^2\varphi \cos \frac{\varphi}{2} \quad \dots\dots(5)$$

from equations (4) and (5)

$$\frac{dT}{T} = \tan \frac{\varphi}{2} d\varphi$$

by integration

$$\ln T + \ln \cos^2 \frac{\varphi}{2} = C$$

$$\text{at } \varphi = 0 \quad T = T_0$$

$$\text{and } T = T_0 \sec^2 \frac{\varphi}{2} \quad \dots\dots(6)$$

Plotted in Fig.(3) the values of yarn tension versus the angle φ as calculated from equation (6), it is evident as the angle φ increases the yarn tension increases.

Since the angle φ is a function of the package stroke it is better to draw the yarn from packages of short stroke than from packages of long stroke. This type of curve will be common for any package under various pre-yarn tension, the only difference will be in the value of tension resulted.

3. EXPERIMENTAL

Apparatus Used Fig.(4)

The apparatus used is composed of three units:

- a) Drawing unit, which draws the yarn from the package at speed ranging between 50 and 200 m/min.

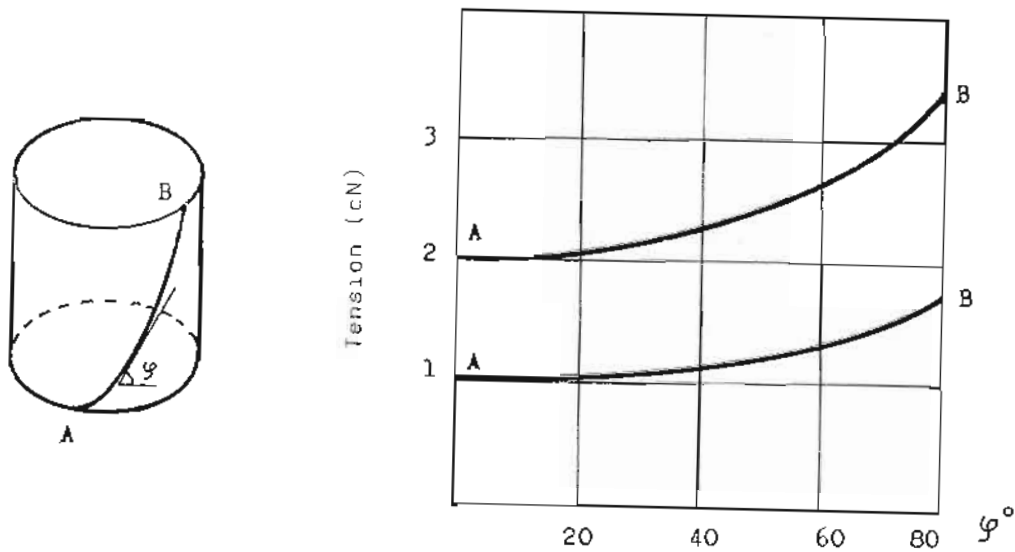

Fig. 3: Theoretical relationship between yarn tension and angle.

- b) Measuring, magnification and recording units, which measure the yarn tension during unwinding, then record it on X-Y recorder.
- c) Package support, the package is supported vertically and the yarn is drawn overhead through guides, then laid horizontally to the drawing unit, through the yarn brake (in case of using yarn brake) and measuring head.

The arrangement has been calibrated in cN-units by using dead weights.

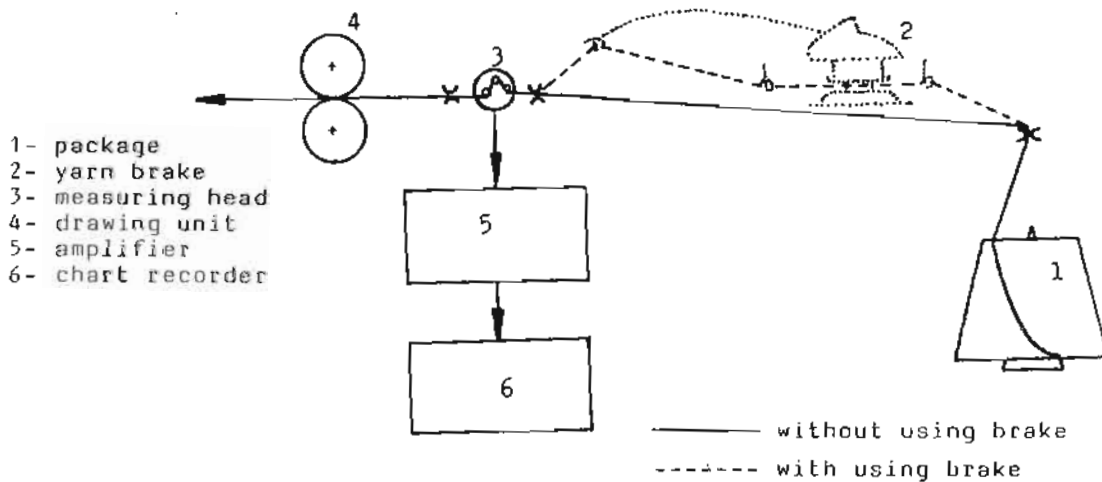

Fig. 4: Arrangement of apparatus.

4. RESULTS

Typical Traces of Yarn Tension:

Shown in Figs. (5,6,7,8,9 and 10) typical traces of tension variation of different package diameter at various yarn speeds.

5. GENERAL DISCUSSION

Without Using Yarn Brake:

For various package diameters, it was found that by increasing the withdrawal speed from 50 to 100 m/min, the yarn tension decreased, due to that at slow speed the static friction (yarn to yarn) is high because the yarn is rubbing the surface of the package. And when the withdrawal speed increases from 100 to 200 m/min, the yarn tension increases, this could be attributed to the formation of a balloon at these speeds. This will lead to the reduction of yarn to yarn contact and the effect of balloon will take place.

With respect to the effect of package diameter on yarn tension value at slow speed (50 m/min) it was found that the yarn tension increase when the package diameter is large, because the angle of wrapping is large (See Fig. 11). Also at 100 and 200 m/min and for package diameter $D = 15$ and 11 Cm the value of yarn tension decreases with the decrease in package diameter. Below 10 Cm package diameter the value of yarn tension increases with the increase in yarn withdrawal speed.

With Using Yarn Brake:

In the case of using yarn brake, generally the value of yarn tension increases compared with the case in which yarn brake is not used.

With respect to the effect of yarn speed in this case it was found that for all package diameters the value of yarn tension decreases with the increase in yarn withdrawal speed because the yarn brake is considered as a self balancing brake.

But with respect to the effect package diameter the value of yarn tension at constant withdrawal speed increases with the decrease of package diameter (for all withdrawal speeds used).



Fig. 11: Angle of yarn wrapping on package edge.

Package characteristic: (acrylic, Nm 28/2)
angle of winding = 15° , stroke = 140 mm, diameter $\bar{D} = 150\text{mm}$, conical $9^{\circ}15'$

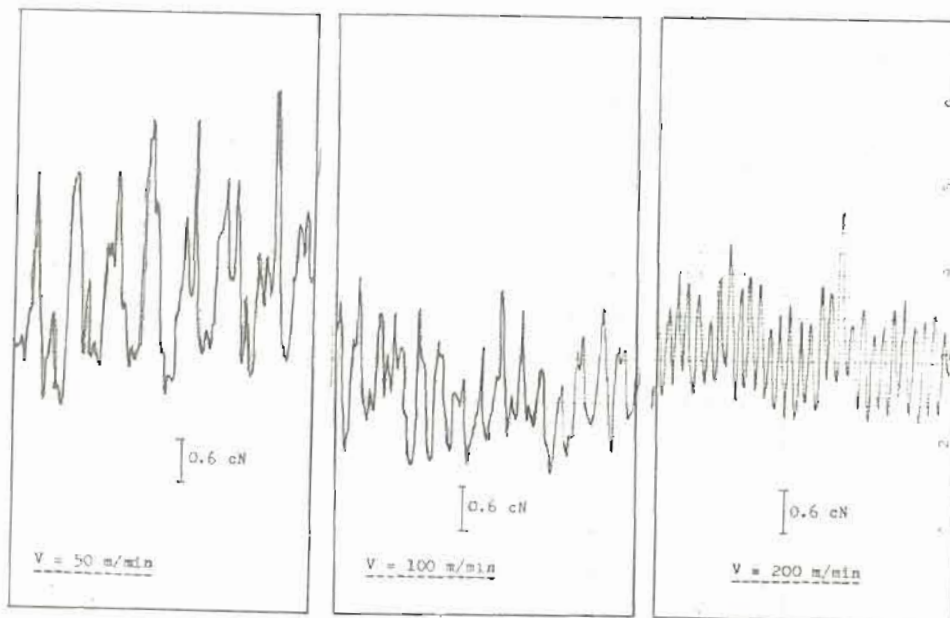

Fig. 5: Typical traces of yarn tension (without using yarn brake).

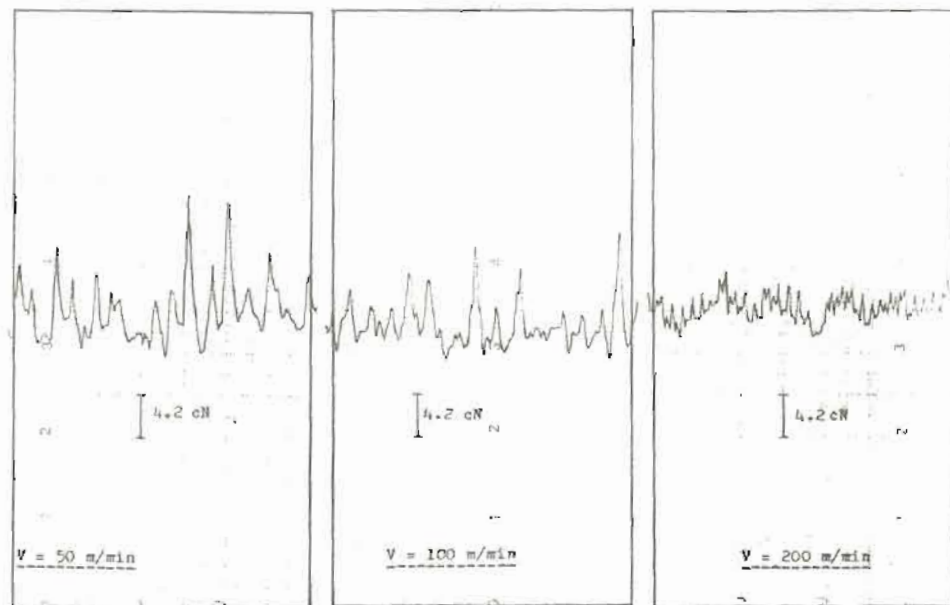

Fig. 6: Typical traces of yarn tension (using yarn brake).

Package characteristic: (acrylic, Nm 28/2)
angle of winding = 15° , stroke = 140 mm, diameter $\bar{D} = 110$ mm, conical $9^{\circ}15'$.

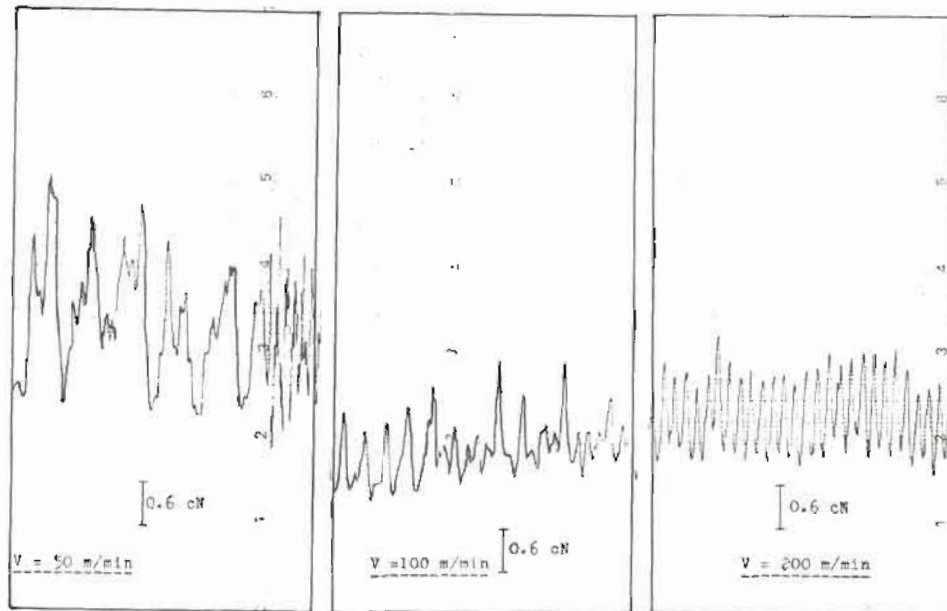

Fig. 7: Typical traces of yarn tension (without using yarn brake).

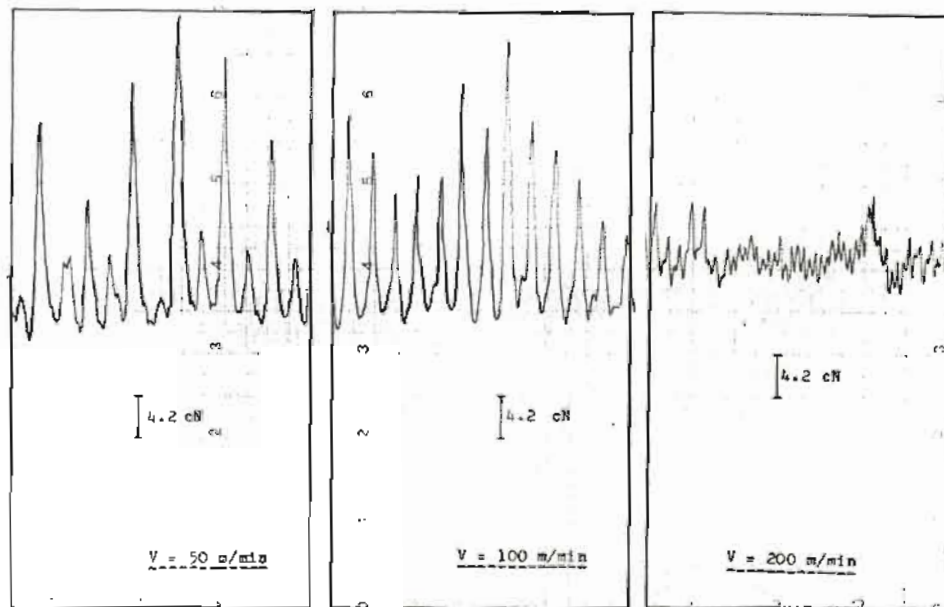

Fig. 8: Typical traces of yarn tension (using yarn brake).

Package characteristic: (acrylic, Nm 28/2)
 angle of winding = 15° , stroke = 140 mm, diameter $\bar{D} = 65$ mm, conical $9^{\circ} 15'$.

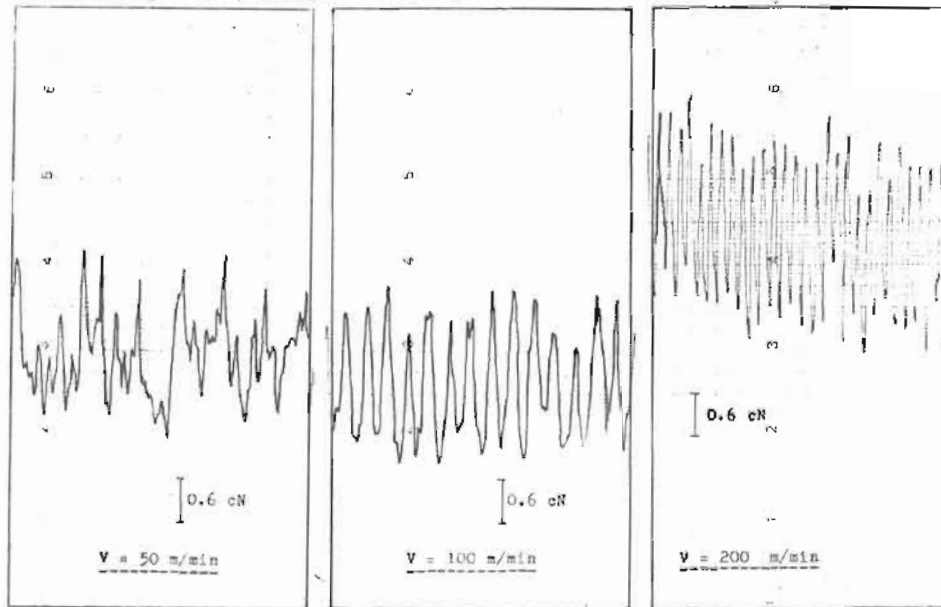

Fig. 9 : Typical traces of yarn tension (without using yarn brake)

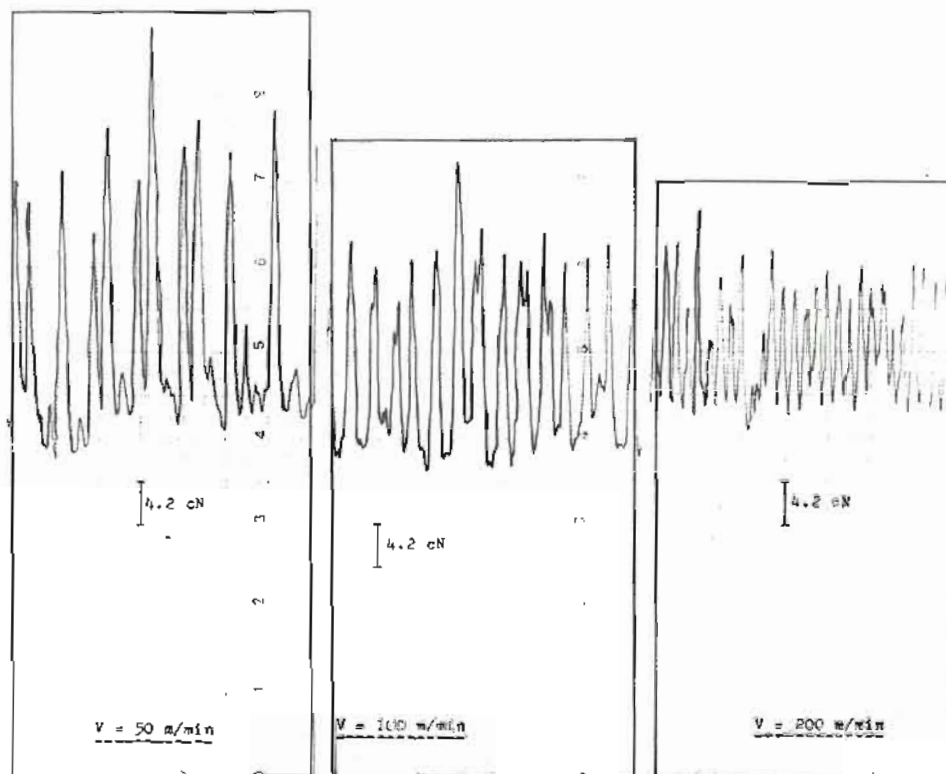

Fig. 10: Typical traces of yarn tension (using yarn brake).

6. CONCLUSIONS & RECOMMENDATIONS

- 1- The package diameter should not exceed 20 cm because with larger package diameter the yarn will slough-off during withdrawal from the package.
- 2- It is preferable to use a package with short stroke because the amplitude of yarn tension fluctuates proportionally to the length of package stroke.
- 3- The core diameter of the package should not be less than a certain limit ($D = 8$ cm), because by withdrawing the yarn at high speed ($V = 200$ m/min), the tension level is high.
- 4- For knitting process package of conical shape is preferable because the wrapping angle between the yarn and the package top-edge is small, since this will lead to a reduction in yarn tension.
- 5- The angle of winding should be as small as possible (but not to the value that would affect the stability of yarn layers within the package) because the rate of yarn tension fluctuation is proportional to the angle of winding.

REFERENCES

1. Padfield, J.I.I. 1955, 171.
2. Booth, British Journal of applied physics 8, (1957) 4, p. 142.
3. Herzog, A., Fehler in Textilien, Heidelberger, Reprographie, W.G. 1958.
4. Pietikainen, L., Melliand Textilberichte 3/1983, S. 196.
5. Petrova, V.A., Melliand Textilberichte 4/1980, S. 335.
6. Knapton, Tex. R.J., 1966, 1072.