

An Innovative System for Picking Mango Fruit

Mohamed, T. H. A.

Agricultural Engineering Research Institute (AEnRI)- ARC, Egypt



ABSTRACT

A mango picking machine was manufactured from selected light materials to be capable to reach to the high position of mango fruits. The innovated design was depended on confirming the right cutting of the stem position to decrease latex bleeding, protecting the fruits from injures and preventing the fruits from fallen down. The picker cutting mechanism was consisted of two circular saws rotated vice versa towards inside direction and faced a counter sharp blade along the two centers of the cutting discs. The machine was tested on three cultivars of mango trees Keitt, Kent, and Tommy Atkins from low-stemmed trees cultivars and distinguished of big fruit volume. Also the fruit stem cross section was measured. The maximum dimensions of the fruits were taken to design the machine. Four types of circular saws at five cutting speeds of (2.78, 4.17, 5.56, 6.97 and 8.34 m/s) were tested and studying the stem cutting efficiency (%) at each treatment. The results indicated that the optimum cutting circular saws were the 100 teeth saw discs with sharp edge when working at linear speed of 8.34 m/s that gave correct cutting stem percentage of 95% and only 5% undercut stems. Also, the results indicated that the optimum counter blade position was underneath the discs with over lapping 5 mm that gave the same cutting efficiency. The calculated power required to cut a fruit stem with a cross section of 87.5 mm² with two circular saws was 3.56watts, meanwhile, the results indicated the measured power was 4.8 watts, while the available power was 5.2 watts. Comparing the effect between manual picking by hook type stick and using the picker the on the fruits injures. In manual picking, the results indicated that the average percentages of (fallen fruits, injured fruits, and latex fruit) were (15.07%, 6.85% and 30.82%) respectively meanwhile, the innovated picker indicated injured percentage (2.28%, 2.43% and 4.86%) respectively. The total fabrication cost of the picker was 1500 LE with 2017 price level. The total operating costs was 21.37 LE/h. The rental value of mechanical was 22.82 LE/h. The picker indicated (NPV) of 844.3 LE at 14 % interest rate. The picker payback period (PBP) was about 1.3 year.

Keywords: Mango picker, Mango harvesting, Fruit picking, An innovated system

INTRODUCTION

Mango (*Mangifera indica L.*) is the queen of the tropical fruits. It is one of the most important tropical fruits marketed throughout the world. Zhenfeng *et al.*, 2009 mentioned that the mango fruits are normally harvested when mature, but not rip then transported and stored at low temperatures (10–15°C) to extend their shelf life. The Arab Organization for Agricultural Development, 2014 stated that on 2013, Egypt produced 712540M tons of mango fruits from cultivated area of 200881 feddan. Publication Central Administration for Agricultural Extension, Ministry of agric., Egypt, 2004 stated that in Egypt, picking mango fruits is usually done at the stage of full maturity or at ripening stage according to distance of the markets from the production area. If the markets are very far from the production area it is usually pick the mango fruits at the stage of complete maturity stage. OECD, 2011 mentioned that the mango fruit ripening stage could be recognized by several methods, including the fruit filling, changing the fruit skin color from dark green to light green or to the color characteristic of the cultivar as well as the transformation of the flesh of the fruit color from yellowish green to yellow.

Wanitchang *et al.*, 2011 mentioned that fruits harvested too early have poor quality as they will not ripened properly. On the other hand, harvesting at an over short shelf life and disease vulnerability. Mango maturity can be monitored with the numbers of days post full bloom or days after fruit set. Skin roughness, fruit firmness, shape, size, shoulder growth and peel color are also subjective parameters for maturity assessment. Brecht, 2010 mentioned that mangos picked before their optimum maturity may eventually ripen, but will develop inferior flavor and aroma, show increased susceptibility to chilling injury caused by low temperatures during transport, and have shortened shelf life. Once the decision to harvest mangos has been made based on maturity index

interpretation, harvest crews should follow recommended picking and field accumulation procedures. In commercial operations, the use of harvesting aid such as ladders, clippers, nets, and harvest baskets is very common and helps speed up harvesting. Instruct harvest workers not to carry or handle ladders by the rungs in order to avoid transferring soil from shoes to rungs to hands to fruit. Hermans, 2008 mentioned that more than fifty years ago, mature stage leads to a harvesting was done using very long/tall ladders while holding or carrying a basket. This involved high risks of fatal injuries by falling. Since sixties decades, low-stemmed trees became standard for some fruits. Lower stemmed trees introduced a more efficient and faster harvesting and a more comfortable standing working posture compared to standing on a high ladder. The fruit picker has to reach above shoulder height or below knee height and twisting of the back occurs. Neck and shoulder discomfort can also be caused by the repetitive movements of the arms when picking fruit and placing it in the container (a bucket, transport bin or pallet box). El-Iraqi *et al.*, 2010 designed and fabricated simple mechanical picking aid for mango fruits. These prototypes consisted of a telescopic pipe, fruit collection pipe and different cutting mechanism. These mechanisms included one disc cutter with gasoline engine, one disc cutter with electrical motor, electrical scissors and cutting edge hook. The results showed that the lowest injured of the fruits were (3-4) %, (4-5) %, and (5-6) % by using the electric scissor, electrical disc cutter, mechanical disc cutter respectively for harvesting Zebdia and Hindi mango. Roger *et al.*, 2016 tested three types of mango handy picker, the pull type, trigger type and modified trigger type equipped with a scissor blade controlled by steel wire to cut the stems. Based on the results compared with the conventional mango picker having an average capacity of 22 fruit/min, the trigger and pull type registered a capacity of 12 fruit /min and 21 fruit /min respectively. Latex stain reduced by 91.77 % for the trigger type picker and 86.88 % for the pull type picker with insignificant number of fallen and

mechanically damaged fruit. OECD, 2011 indicated that the mangoes must not have any damage or injury spoiling the integrity of the produce. The mangoes must be free from disease or serious deterioration which appreciably affects their appearance, edibility or keeping quality. It classified the rejected fruits according to the status of the fruits in growing season such as (sunburn, anthracnose, bacterial black spots, external and internal symptoms, chemical residue, shrivelled fruit, slight skin defects and damage caused by low temperature) and some damage due harvesting (unhealed crack, stem end rot, brushing damage, soiled fruit with some damage caused by contact with soil, skin defect due to rubbing and resin exudation). Brecht, 2010 mentioned that Latex dripping from mango stems at harvest or during accumulation and transport causes peel damage that is aggravated when mangos are exposed to heat treatment. To prevent the peels latex damage, the following procedures are recommended to Harvest mangos with a long stem (5 cm or longer) and accumulate the fruit in field boxes. Latex does not drip from fruit with a long stem attached. Trim stems to the abscission zone (approximately 1 cm) and immediately place the fruit with the stem end down to allow latex to drip without touching the fruits peel. The duration of latex removal varies from 20 minutes to up to 4 hours, depending on how long it takes for the latex to stop dripping. Abourayya *et al.*, 2011 studied some physical characteristics for Tommy Atkins, Kent, and Keitt, cultivars at maturity stage for two years. They found the fruit averages weights were (443.86 , 478.43, and 586.65 g), the fruit averages volumes were (437.75, 468.27, and 573.58, cm^3), fruit averages lengths were (12.48 , 10.22, and 12.98 cm), fruit averages width were (8.27, 9.12 ,and 10.43 cm) for Tommy Atkins, Kent, and Keitt cultivars respectively. Also, Spreer and Müller, 2011 find a mathematical relation between some dimensional proprieties of mango 'Chok Anan cultivar' and its weight. Fruits were measured with respect to their length, maximum width and maximum thickness, to within an accuracy of 1.0 mm, and their mass was determined to within an accuracy of 0.1 g. An equation was proposed in order to calculate the mass of the mangoes based on three geometric dimensions, which then showed a high level of explanatory power of $R^2 = 0.97$. The root mean standard error of 12.22 was determined, and the mean relative deviation found was 0.05. Based on measurements taken from the digital photos, the equation was then used to determine the estimated mass based on three dimensions. Estimated and measured values were plotted against each other. A high correlation ($R^2 = 0.96$) was found between measured and calculated mass. Medina and García ,2002 mentioned that the dimension of the cultivars were differ from origin to another. The keitt were fruit shape – ovate, green ground color yellow, blush was red-pink to bronze ,mass from 400 g to 1000 g ,average length was 130 mm ,average width was 90 mm ,average depth was 85 mm, meanwhile Kent cultivar specifications were fruit shape was ovoid, ground color was green/yellow, blush was red/purple, average weight was 400 to 1000 g (avg. 512 g) ,average length was 104 mm ,average width was 76 mm, average depth was 90 mm. Roger *et al.*, 2016 divided the mango tree harvesting zones to upper zone, middle zone and lower zone. They mentioned that the upper zone is the hardest zone to

harvest. They divided the picking positions to upper position, middle position, lower position and climb position.

Also, Srivastava *et al.*, 2006 specified cutting as a process that causes mechanical failure of plant stems and/or leaves and thus the structure and strength of plant materials are of interest. The engineering properties of plant parts are not as well understood as those of more common made. Structurally, the stems engineering materials such as steel, but some engineering studies of plant materials have been viewed as materials with fibers of high tensile strength oriented in a common direction and bound together by material of much lower strength.

In Egypt, the common methods to pick mango fruit is picking the lower zone fruit stem by hand pruning sessor and pick the middle and high zones fruits by using a stick with steel hook or a cane fixed to a stick. Picking crew always consents of two persons, one for picking and another for picking up the fallen fruit in the air. If the fallen fruit hit the ground from high position it surly effected by skin injures, cracks, and bulb deformation. This reduces the fruit quality score, hampers the operation the fruit maturation post harvesting, and reduces fruit marketing.

The aim of this research is developing and manufacturing an innovating mango picker equipped with an innovated method for cutting fruits stems. The picker was manufactured from available parts in the local market and made from selected light materials to be capable to reach the high position of mango fruits up to four meters. The design was depended on confirming the right cutting of the stem position to decrease latex bleeding, protecting the fruits from injures and preventing the fruits from fallen down.

MATERIALS AND METHODS

The designed picker was manufactured from light components and materials carefully selected to fulfill the required forces necessary to cut the mango fruits stems from common cultivars. The picking system was designed basically to prevent fruit injured, fallen, cutting fruit stem length of 50 mm or more, and sterilize the cutting blades to prevent diseases infection between plants. The first step of picking was put the fruit inside a basket to insure its un-fallen to the ground. Then, the operator moved the picker towards fruit stem to cut it by double rotating disc saws at the required cutting length of (50mm). The cutting discs were located above the basket by 50 mm to achieve the required length of cutting stem (50mm or more) to decrease latex bleeding and latex skin burning. The Innovated picker was consisted of six sub-systems:-

1. Chassis: The main chassis was made of two aluminum angle with cross section of (35mm×35mm× 4mm thickness) and length of 305mm. Both angels were perpendicularly articulated on a fixed aluminum bar with thickness of 3 mm by bolts and nuts. A plastic female threaded holder fixed on the aluminum bar to fit a telescopic picking hand stick and to disassemble during transportation. Two bolts were fixed at the end of the chassis to adjust the cutting discs overlapping.

2. Cutting head:

Cutting discs: Two steel circular saw discs with an outer diameter of 100 mm and an inner diameter of 20 mm. The disc inner diameter was fitted to disc holder and locked by plastic nut. A 6 mm diameter steel rotating shaft was

passed through the disc holder and locking by pin. There was a plastic spacer between the plastic locking nut and the metal disc worked as an overload clutch allowed the base of disc holder to slip during clogging. The steel shafts were rotated inside bearing made of special copper alloy that placed in a plastic base housing locked to the chassis by plastic wing nut. A sharp fixed blade was fitted underneath the saws and work as counter blade. Both discs rotated vice versa towards a fixed counter sharp blade.

Transmission system: The mechanical transmission was selected to keep a constant power from the electrical motors. The motion was generated by two DC 12 V motor. Two drive pulleys made of aluminum alloy with diameter of 85 mm and thickness of 10 mm were fitted on the motors shafts. The motion was transferred via double cogged V belt to the two steel driven pulleys diameter of 16 mm coated with nickel and locked to cutting disc shaft.

Fig. (1) shows the cutting head and its components. Also, Fig. (2) shows an image of cutting head.

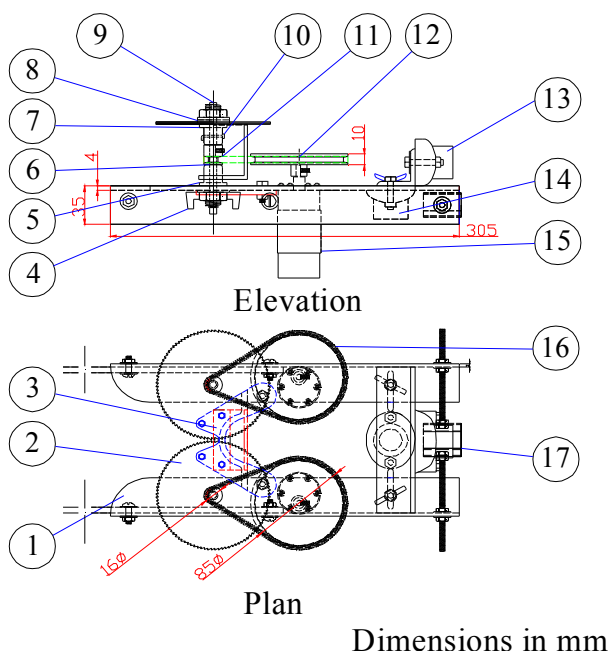

Fig. 1. Schematic of the components of the cutting head

- (1) Chassis, (2) Cutting disc, (3) Fixed counter sharp blade,
- (4) Plastic wing nut, (5) Plastic base housing, (6) Driven pulley,
- (7) Disc holder, (8) Overload clutch, (9) Locking nut,
- (10) Locking pin, (11) Journal bearing, (12) Drive pulley,
- (13) Horizontal picking hand fitting, (14) Vertical picking hand fitting,
- (15) DC electrical motor, (16) Double cogged V belt,
- (17) Adjustment cutting discs overlapping.



Fig. 2. Image of the cutting head

3. Basket: The picker was equipped a basket with elliptical shape entrance to make the basket ring. This shape allowed to select a certain fruit from the fruit branch, isolated it then drive cutting tools towards it. The maximum dimensions of the selected fruits cultivars (Tommy Atkins, Kent, and Keitt) were measured. The maximum fruits lengths were (170, 140, 175) mm, the maximum fruits widths were (87, 107, 123) mm for Tommy Atkins, Kent, and Keitt respectively. Then, the dimensions of the ring were 235mm length, 230mm width and 400mm depth suit to common mango cultivars in Egypt. These dimensions of the basket ring were selected to be bigger than the diameter of the common fruit mango cultivars. Two basket rings was manufactured to match the small dimensions cultivars and another for big fruit dimensions cultivars. The overall weight of the chassis, cutting head and basket was 650 g.

4. Telescopic picking hand stick: The telescopic picking hand stick was consisted of two light hard steel pipes with overall length of 3 meter. The outer pipe length was 1.5 m with diameter of 30 mm, while the inner pipe length was 1.5m with diameter of 25 mm. Both pipes thickness was 0.5 mm. A twisted plastic lock was attached in the end of the outer pipe unfasten when the inner pipe get out. The picking hand was equipped with on/off push type switch key. The switch key was supported on a switch holder fixed on a plastic pipe 35 mm diameter freely moved along the outer pipe. The experiments indicated that operator always needed to hold the hand stick from many different positions by both hands to reach the determined collected fruit. In this case the fixed type push type button in the end of the stick would not available to the operator hand.

Fig. (3-A) shows a schematic of telescopic picking. Also, its image Fig. (3-B) shows its image.

5. Electrical components and electrical circuit: Two electrical DC 12 volts motor; Sgmada make, model SG-555123000-10K, Chinese made were supported to aluminum picker chassis by bolts. Each motor had a built in transmission system. The main motor unloaded speed was 3000 rpm meanwhile, the motor shaft speed after reduction was 300 rpm. The motor output power was 2.9 W while the loaded torque was 1.3 Kgf. cm. The electrical power was generated from a 12 V rechargeable battery with initial current of 7 ampere. The current was transmitted to the motors via electrical wire inside the telescopic picking hand stick. Near the upper end of the stick, it was equipped with electrical quick coupling socket near the cutting head to split it up during transportation and another one near the its base to split the battery up. The battery was hanged with shoulder bag. A researchable unit 12V, 3A was used to charge the battery from the AC current. Fig. (4) shows the elements of the electrical circuit.

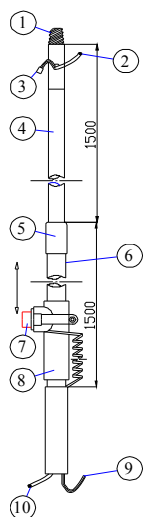

A. Schematic of telescopic picking hand (1)Threaded plastic lock,(2)Spraying solution tube,(3)Electrical male socket ,(4) Inner steel stick,(5)Telescopic stick lock,(6)Outer steel stick,(7) Push on/off switch, (8)Swing hand,(9)Electrical connect to battery, (10) Connecting tube to sterilization unit.



B. An image of telescopic picking hand stick equipped with swing type push on/off switch.

Fig. 3. Telescopic picking hand stick.

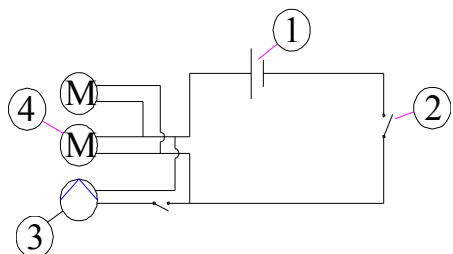

Fig. 4. Electrical circuit

- (1)12 Volt Battery, (2) On/Off electrical push button,
- (3) Sterilization solution pump (4) DC electrical motor

All the cutting tools were installed in a light plastic casing thickness of 0.75 mm to protect the other fruit from injured during operation.

6. Sterilization unit: The picker was equipped with spraying unit to sterilize the edge of disc blades during moving from tree to another to protect the trees from viral and fungal infections. The sterilization unit was consisted of an electrical 12 V pump pumped a sterilization solution from 3 liter plastic tank via flexible clear plastic pipe to two spraying sprinkler located near the cutting discs. The pump was begun to operate when pushing the push (on/off) button switch or when changing the harvested tree. The tank, pump and the battery were placed in bag hanged on the operator back. Fig. (5) shows a schematic of the components of sterilization tank and attached pump.

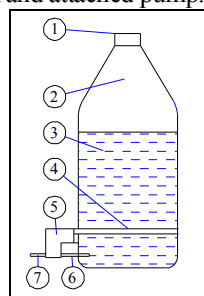

Fig. 5. Sterilization pump and solution tank.

- (1) Solution tank cover,(2) Solution tank ,(3)Sterilization solution ,
- (4)Pump support , (5) Sterilization pump,(6) Inlet pumping tube ,
- (7) Outlet pumping tube.

Fig.(6) shows a schematic of the components of the manufactured picker. Also, Fig.(7) shows an image of the manufactured picker during operation.

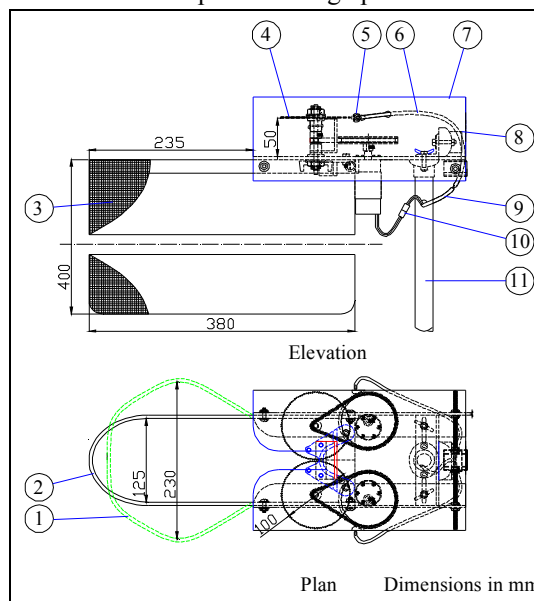

Fig. 6. Schematic of the manufactured picker

- (1),(2)Basket rings,(3)Basket,(4)Cutting disc,(5)Spraying nozzle,
- (6) Spraying tube ,(7)Plastic cover,(8)Horizontal picking hand fitting ,
- (9)Spraying tube, (10)Electrical female socket,(11)Telescopic stick.

Measuring instruments:

- 1- Stopwatch: to record the time consumed during calculation productivity at different treatments.
- 2- Vernier caliper: to measure the dimension of the stem length and dimensions of the fruits, with accuracy 1/20 mm.
- 3- Tachometer: to measure the rotation speed of the cutting disc shafts (rpm).
- 4- Ampere clamp meter: to measure the resistance (A).
- 5- Image scanner: to image the stem cross section with graded ruler in mm. Then, the images downloaded on AutoCAD program to measure the stem cross section area in **mm²** .



Fig. 7. Image of the manufactured picker during operation

Testing procedure: The experiments were carried out at mango farms at Nobaria, El-Behera Governorate at three cultivars of mango trees Keitt, Kent, and Tommy Atkins. These cultivars trees were from low-stemmed trees cultivars and the fruits were tended towards the ground

Table 1. Changing the speed of the cutting disc shafts

Motor type	Motor speed (rpm)	Drive pulley diameter (mm)	Driven pulley diameter (mm)	Cutting shaft speed (rpm)	Saw cutting disc linear speed (m/s)
SG-555123000-30K	100	85	16	531	S ₁ 2.78
SG-555123000-20K	150	85	16	797	S ₂ 4.17
SG-555123000-15K	200	85	16	1063	S ₃ 5.56
SG-555123000-10K	300	71	16	1331	S ₄ 6.97
SG-555123000-10K	300	85	16	1594	S ₅ 8.34

(2) **Disc cutting blade edge type:** Four types of cutting discs with 100 mm diameter were used. (plan discs, 100 teeth saw discs, 50 teeth saw discs, and



Plan discs, 100 teeth discs, and 50 teeth discs

direction. The maximum height of the trees was 4 meters. The picker could reach the four meter mango tree with telescopic hand of 3 meter and extra length of the operator. The picking picker was used to pick the fruits by cutting the fruit stem at the required length (50mm) at different treatments. Twenty (20) mango fruits were picked at each treatment according to Wanitchang *et al.*, 2011; each treatment was separated and checked for stem cutting length, and injuries. Manual picking was made in parallel at same time under the same conditions.

Test factors: The following treatments were studied to evaluate parameters affecting the performance of the designed picker:-

(1) **Cutting disc speed :** Five cutting saw shaft speed were used. The cutting disc speed was changing by replacing drive motors and drive pulleys. The motors had built in reduction gears to decrease the motor shaft speed from 300 to 100rpm.

modified 100 teeth saw discs with sharp edge). Fig.(8) shows the types of cutting discs.



Modified saw disc (100 teeth with sharp edge)

Fig. 8. Types of cutting discs

(3) **Discs overlapping:** (0, 5, 10 and 15 mm).

(4) **Counter blade position** (under the discs, between the discs, and upper the discs)

Fig. (9) shows the Circular saws overlapping and counter blade positions.

Measurements and calculations: -

(1) **Stem cutting efficiency (η_{1c}) :-**

The stem cutting efficiency was calculated according to Brecht, 2010 by counting the numbers correct cut stem length (50mm or more), under cut stem length (less than 50mm) and un-cut stems in each treatment. Under cut stem caused more latex bleeding causes fruit skin burning:-

$$\text{Correct cut fruit stems(\%)} = \frac{\text{No. of correct cut fruit stems}}{\text{Total no. of cut fruit stems}} \times 100. \quad (1)$$

$$\text{Under cut fruit stems(\%)} = \frac{\text{No. of under cut fruit stems}}{\text{Total no. of cutfruit stems}} \times 100 \quad (2)$$

$$\text{Un cut fruit stems(\%)} = \frac{\text{No. of un cutfruit stems}}{\text{Total no. of cutfruit stems}} \times 100 \quad (3)$$

(2) **Fruit picker productivity. (Fruit/min) and fruit evaluation:-**

Fruit picker productivity was determined according by calculating the number of picked fruits per min from high location. Also, the manual picking was made by labors using stick equipped with hook for only high location fruits. Comparison between manual picking and modified picker methodology was made according to Roger *et al.*, 2016 mentioned that the performance evaluation for mango picker was based on harvest capacity fruit/ min, percentage of fruit bruises, percentage of latex skin burning and percentage of fallen fruit. The fruit picker and manual picking were tested for two mango trees with visually the same number of fruits.

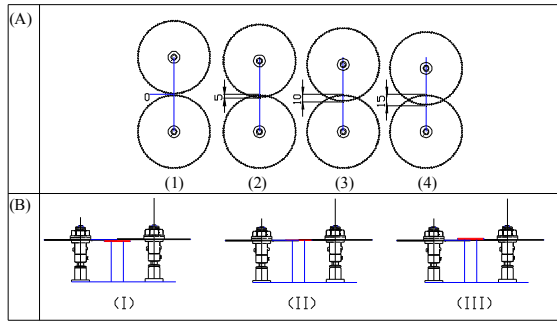

Fig. 9. Circular saws overlapping and counter blade position

(A)Circulars saws overlapping :(1) Zero mm; (1) 5 mm; (3) 10 mm; (4) 15 mm.

(B)Counter blade position :(I) Under the discs; (II) Between the discs; (III) Upper the discs.

(3) Cost analysis and economical evaluation: -

The cost analysis was calculated according to Oida, 1997.It performed in two steps. The first step is to

$$T_c = \frac{\left\{ \left[\frac{Pc - Sv}{Y} \right] + \left(\frac{Pc + Sv}{2} \times \frac{i}{100} \right) + (0.02 Pc) \right\} + \left[\left(\frac{Pc \times r_c}{Y} \right) + (Pt \times nh \times f_{kW}) + (N_l \times L_c \times n_a) \right]}{n_a} \dots\dots (6)$$

where;

- Pc = Picker manufacture price, LE;
- Sv = Salvage value=5% from the Picker manufacture price LE;
- i = Interest rate =14%;
- r_c =Coefficient of repair and maintenance = 100%;
- Y = Machine age = 5 years;
- Pt = battery consumed charge power (transformer (220 V to 12V)charging time to make the battery reached to the full charge) , kW/h;
- nh =Number of charging hours, h;
- f_{kW} =Electrical kW price =1kW=1 L.E;
- $N_l = \pi r^2$ = Number of labors = harvest crew(2 labor);
- L_c =Labor cost = 70 L.E day, day(7 hours) , LE/h;
- $n_a = \pi r^2$ = Annual working hours = 500 h, h/year.

Power determination:-

The method of changing the cutting discs speed mechanically was chosen without using electric resistors or multiple speed motors to measure the exact required power required to cut mango fruit stems. To calculate the predicted cutting power the following equation was used according to Andis and Henn, 2014, (Stanford , 1980, 1985&1993) &Thin Kerf Technologies ,2016. :-

$$E = \frac{C \times k \times f_{Max} \times D}{constant} \dots\dots (7)$$

where;

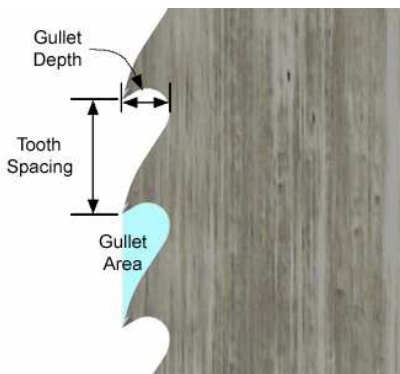

- E = Estimated required power, hp;
- C = Specific cutting work, $joule/cm^3$, = 35 for softwoods, 40 for dry fir, and 70 for hardwoods;

calculate the cost of the materials and fabrication. The second step is to calculate the mango picker operating cost. In order to evaluate the financial viability of the picker, three parameters computed and analyzed. These parameters are the picker operating cost, the net present value (NPV) and the payback period (PBP).Also, a comparison between manual picking cost and mechanical picking cost is conducted.

These costs include depreciation (D), annual capital interest taxes (I), housing and insurance (THI), repair and maintenance(R), power cost (F), and labor cost (L).

$$T_c = \frac{\{[(D) + (I) + (THI)] + [(R) + (F) + (L)]\}}{n_a} \dots\dots (5)$$

where;

- T_c = Total cost, LE/h;
- n_a = Annual working hours = 500 h, h/year.

k =Kerf, m;

$$k = h + 2 \times s \dots\dots\dots (8)$$

h =Thickness of saw disc = 0.09, cm;

s =Side clearance =0.01, cm.

f_{Max} =Maximum recommended feed speed (m per minute) can be calculated as:-

Fig. 10. Saw gullet area.

$$f_{Max} = \frac{GFI_{Max} \times a \times c}{D \times P} \dots\dots (9)$$

GFI_{Max} = Maximum allowable Gullet Feed Index = 0.3 for circular saws.

a = Gullet area measured (cm^2) as shown in Fig. (10), measured =0. 015 cm^2 .

c =Blade (or rim) speed can be calculated as:-

$$c = 3.14 \times d \times N \dots\dots\dots (10)$$

d = Circular saw diameter=10 cm;

N = Shaft speed= 1594 rpm.

D = Depth of cut=0. 5 cm;

P = Tooth pitch=3pitch/ cm.

$$E = 0.0024268 \text{ hp} = \frac{0.0024268 \times 1000}{1.35962} = 1.784958 \text{ W}$$

Predicted cutting power = $E \times n_d$ (11)

where;

n_d = number of cutting units =2

Predicted cutting power =3.569917 W

Nominal power= Available power= (P_n) = $P_m \times n_m$

Where;

P_m = Motor nominated power, Watt;

n_m = Number of motors.

$P_n = 2.6 \times 2 = 5.2$ Watt

Available power (5.2W) > Predicted cutting power (3.569917W)

Predicted power and actual power:

The experiments were made to cut different fruit stems cross sections with the picking machine. The current strength was measured. The Actual power requirement (P_a) was calculated from the following equation according to Theraja and Theraja, 2005:

$$P_a = I \times V \dots\dots\dots (12)$$

where;

P_a =Total power requirement for the picker, W ;

I = Current strength, Amperes;

V =Potential difference, Voltage.

An ampere clamp meter was used to measure current strength when the machine was unloaded. Then, the current strength was measured to calculate the loaded power at different stem cross sections. The consumed cutting power is the result of subtract the loaded power from unloaded power. Fig. (11) shows the consumed cutting power at different stems cross sections.

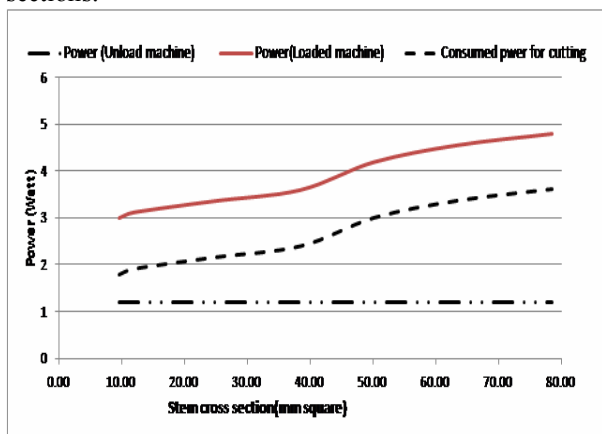

Fig. 11. The consumed cutting power at different stems cross sections.

The results indicated that loaded power at maximum stem cross section $87.5mm^2$ was $4.8W$ less than the available power $5.2W$.

RESULTS AND DISCUSSION

• The effect of cutting disc edge, disc linear speed on cutting efficiency (η_{1c}) :-

The experiments were carried out to pick mango fruits at the high position to study the effect of disc linear speed on cutting efficiency. The average values of cutting efficiency (%) were taken at cutting disc linear speed of ($S1=2.78$, $S2=4.17$, $S3=5.56$, $S4=6.97$ and $S5=8.34$ m/s) by changing the motors and drive pulleys. The experiments were carried out with lower position

counter blade under four types of disc (plan discs, 50 teeth discs, 100 teeth discs and modified 100 teeth discs). The treatments made to determine the optimum disc type and its optimum speed. The correct stem cutting length percentage (50 mm length or more) was the effective parameter that evaluated the performance of the picking machine. Fig. (12) shows the effect of cutting disc edge, disc linear speed on cutting efficiency.

The results indicated that the circular plan discs failed to cut the fruits stems at discs linear speed of (2.78, 4.17, 5.56 and 6.97m/s) meanwhile, it was only succeeded to cut the stems with average cutting percentage of (5%) at disc speed of 8.34 m/s.

Also, from Fig. (12), it is found the increasing of cutting disc linear speed increase the total cutting percentage. The maximum total percentage of cut (100%) was found with (100 teeth circular saw discs) and (modified 100 teeth circular saw discs) at linear speeds 6.97 m/s and 8.34 m/s.

When using 50 teeth circular saw discs the picker could not cut the stems at speed of 2.78 m/s. The correct cutting stem percentage was reached only 5% at speeds of 4.17 and 5.56 m/s. Then, the correct cutting percentage increased by increasing the linear speed from 5.56 m/s to (6.97 m/s and 8.34 m/s) by (50% and 80%) respectively. Meanwhile, the under-cut stem percentage disappeared at disc linear speed (2.78, 4.17, 5.56 and 6.97 m/s), and only appeared by (5%) at linear speed of 8.34 m/s. Also, when the linear speed was increased from 2.78 m/s to (4.17, 5.56, 6.97 and 8.34 m/s) the uncut stem percentage was decreased by (5.00%, 5.00%, 10.00% and 30.00%) respectively.

When using 100 teeth circular saw discs, the correct cutting stem percentage was increased by increasing the linear speed from 2.78 m/s to (4.17, 5.56, 6.97 and 8.34 m/s) to (66.67%, 93.75%, 94.44 and 91.44%) respectively. Meanwhile, the under-cut stem increased 50% when the speed increased from 2.78 m/s to 4.17 m/s; then its percentage was 10% at speeds (4.17, 5.56, 6.97 and 8.34 m/s).also, when increasing the leaner speed from 2.78 to (4.17 and 5.56 m/s) the uncut stem percentage was decreased by(16.67% and 55.89%) respectively . then, the uncut ratio was disappeared at speeds 6.97 and 8.34m/s.

By using the modified 100 teeth circular saw discs, the correct cutting stem percentage was increased by increasing the disc linear speed from 4.17 m/s to (5.56, 6.97 and 8.34 m/s) by (76.47%, 77.78%, and 78.95%) respectively. Meanwhile, the under-cut stem percentage was 10% at linear speeds (from 2.78 m/s to 4.17 m/s) then decreased to 5% at linear speed 8.34 m/s. When increasing the speed from 2.78 m/s to (4.17m/s and 5.56 m/s), the un-cut stem percentage was decreased percentage were 22.22% and 94.44% respectively. By increasing the liner speed to 6.97 and 8.34 m/s, the uncut stem percentage was disappeared.

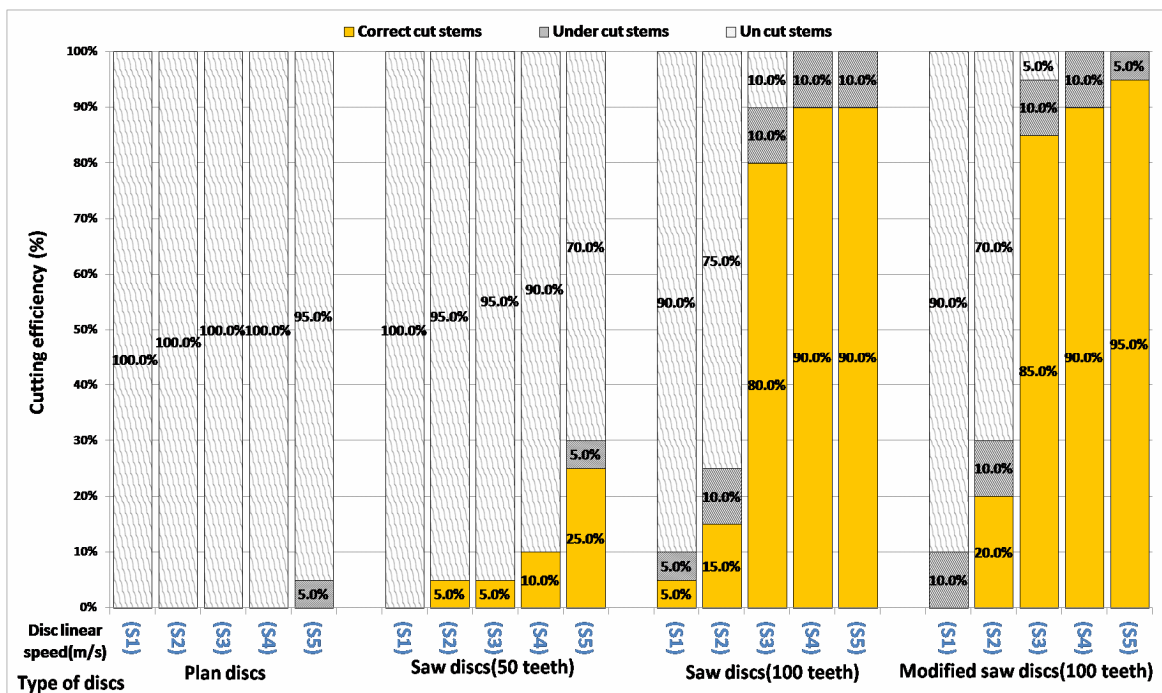

Fig. 12. The effect of cutting disc edge, disc linear speed on cutting efficiency.

The results indicated that the optimum cutting disc were the modified 100 teeth saw discs type when working at linear speed of 8.34 m/s that gave correct cutting percentage of 95% and only 5% undercut stems.

• The effect of counter blade position and discs overlapping on cutting efficiency (η_{LC}) :-

The experiments were carried out to pick mango fruits at the high position of the trees with the optimum

cutting circular disc type (the modified 100 teeth saw discs) and optimum linear speed 8.34 m/s to study the effect of counter blade position, and discs overlapping on cutting efficiency. Fig. (13) shows the effect of counter blade position and discs overlapping on cutting efficiency.

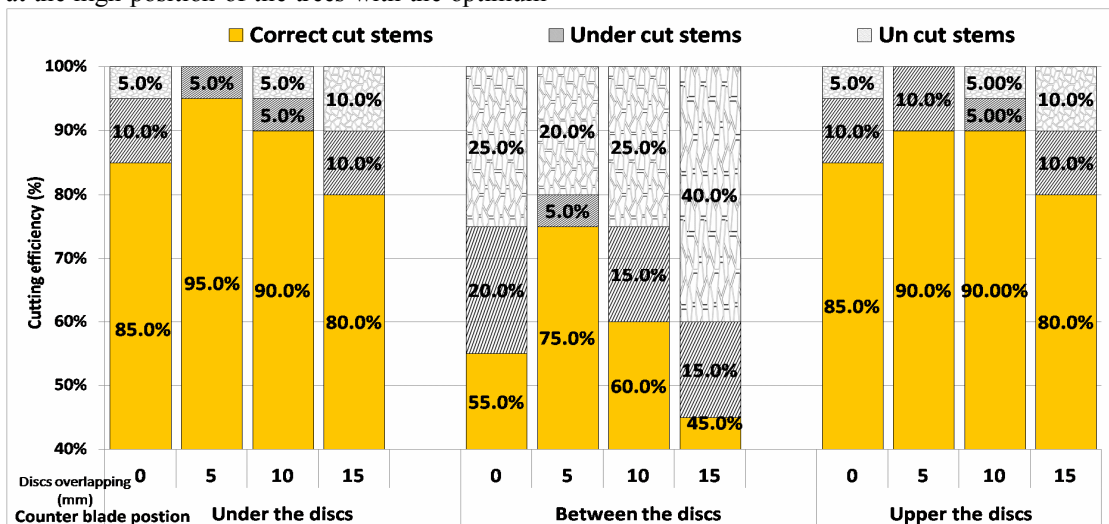

Fig. 13. The effect of counter blade position and discs overlapping on cutting efficiency

When fitted the counter blade under the discs without overlapping to (5 and 10mm), the correct cutting percentage increased by 10.53 % and 5.56 % respectively. Then, the correct cut percentage decreased by 5.88 at disc overlapping 15mm. when increasing the over lapping from 0 mm to (5 and 10mm) the undercut percentage decreased from 10% to (5% and 5%) respectively then was returned to 10% at 15mm discs overlapping. The uncut stem percentage decreased from 5% to zero% at overlapping 0 and 5 mm overlapping, the increased to 5% and 10% at overlapping 10 and 15 mm. The results of counter blade

position upper the disc were very near to the results of under the discs counter blade position except the decreasing of the correct cut percentage at 5 mm overlapping by 5%.

When fitted the blade between the discs, the correct cut max. percentage was 75%. When increasing the overlapping from 0 to (5 and 10mm) the percentage was increased by 26.67% and 8.33% then the percentage was decreased by 18.18% at 15mm overlapping. When fitting the counter blade between the discs it realized the latex stuck on the blade surface causing discs clogging.

The results indicated that the optimum counter blade position was under the discs with over lapping 5 mm at linear speed of 8.34 m/s with 100 teeth circular saws modified with sharp edge.

• **Effect of the picker on fruit injures comparing to manual picking:-**

Comparing between the effect of the picker and the manual picking by hook type stick on the fruits injures. By using the hook stick, the results indicated that the average percentages of fallen fruits, injured fruits, and latex fruit were (15.07%, 6.85% and 30.82%) respectively. The average percentage of total damage was 52.74%; meanwhile the average percentage of right harvested fruits was 47.26%. Using the hook stick causing fruits sudden fallen and missing of picking up hit them into ground causing hidden bruising inside the fruit flesh appeared after few hours. On the other hand, using the innovated picker indicated the average percentages of fallen fruits, injured fruits, and latex fruit were (2.28%, 2.43% and 4.86%) respectively. The average percentage of total damage was 7.28%; meanwhile the average percentage of right harvested fruits was 92.72%.

• **Picker Cost analysis and economical evaluation:-
Picker operation cost:-**

The calculation of operating costs included fixed and variable costs were made for the picker. The total operating costs for the picker was 21.37 LE/h.

Economical feasibility of the developed picker:-

The total fabrication cost of the picker was 1500 LE with 2017 price level. The total operating costs was 21.37 LE/h. The rental value of mechanical was 22.82 LE/h. The picker indicated (*NPV*) of 844.3 LE at 14 % interest rate. The picker payback period (*PBP*) was about 1.3 year.

• **Picker productivity with the ideal adjustment comparing to manual picking:-**

The labor with assistant person could pick an average of 22 fruit/min with the manual hook stick from position of the tree. Meanwhile, the picker could pick an average 20 fruit/min and from high position. It was better to increase picker productivity by additional person for emptying the basket. The labors cost equal 97.1 % from the picker operation cost/h. The picker hourly cost was 21.37 LE/h with fruit picking cost 0.0178 LE /fruit. On the other hand the manual hook stick picking was 20 LE/h (2 person cost) with 0.0152 LE /fruit. Comparing both types of harvest productivity with the fruit injured ratio (52.74% in manual harvesting and 7.28% using innovated picker). It was realized that the farmer could sell 52.74% from the crop with low price due fruit injured. Using the picker is surely increase the market value of the mechanically picked fruits due to the picker keeps them without damage.

SUMMARY AND CONCLUSION

The obtained results can be summarized as follows:-

- 1- The results indicated that the circular plan discs failed to cut the fruits stems. Also, the increasing of cutting saws disc linear speed increases the total cutting percentage.
- 2- The picker success to pick mango fruits the optimum linear speed of 8.34 m/s with modified circular saws

with 100 sharp edge teeth with double discs over lapping 5 mm and the counter blade position is under the discs that gave correct cutting percentage of 95% and only 5% undercut stems.

- 3- Using the innovated picker, indicated the average percentages of right harvested fruits, fallen fruits, injured fruits, and latex fruit were (2.28%, 2.43% and 4.86% and 92.72 %) respectively.

Meanwhile, using the innovate picker decreased the fallen fruits ratio, injured fruits ratio, and latex fruit ratio by (84.89%, 64.55% and 84.25%) respectively and increasing the right harvested fruits by 49.03 %.

- 4- The results indicated that calculated power required to cut a fruit stem with a cross section of 87.5 mm² was 3.56watts, the measured power was 4.8 watts, meanwhile the available power was 5.2 watts. This means, selecting right power using light motors and decrease the battery discharge.

- 5- Comparing the average (productivity, total fruit injured ratio) for the manual picking and innovated picker there were (22 fruit/min, with damage ratio of 52.74%). Meanwhile, with the picker productivity was average (20 fruit/min with damage ratio of 7.28%). this mean the farmer would sell 52.74% from the crop with low price due fruit injured. Using the picker is surely increase the market value of the mechanically picked fruits due low damage.

- 6- The picker can be manufactured locally with cheap price for farmers. The total fabrication cost of the picker was 1500 LE with 2017 price level. The total operating costs was 21.37 LE/h. The rental value of mechanical was 22.82 LE/h. The picker indicated (*NPV*) of 844.3 LE at 14 % interest rate. The picker payback period (*PBP*) was about 1.3 year.

The following conclusions and recommendations can be drawn:-

- 1- It is recommended to pick mango fruit in the early morning and afternoon and avoid noon time when latex bleeding increasing during harvesting.
- 2- Using latex bleeding table is surely decrease the latex burning where the fruits put upside down until latex bleed is finished.
- 3- Avoid noon time harvesting where the sun rays perpendicular at the operator eyes.
- 4- It is better to use the picker for high location fruits and use the trimming scissor for near fruit to increase labor productivity. The right branches trimming and land clear is definitely effect on the performance of the labor.

REFERENCES

- Abourayya , M.S.; N.E. Kassim ; M.H. El-Sheikh and A.M. Rakha. (2011). Fruit physical and chemical characteristics at maturity stage of Tommy Atkins, Keitt and Kent mango cultivars grown under Nubariya conditions. *Journal of American Science*, 7(3).
- Andis Ā. and T. Henn. (2014). Relation between mechanical and electric power at longitudinal sawing. *Forestry and wood processing. Research for rural development. Volume (2).*

- Brecht J. K. (2010). Mango post harvesting, best management and practices manual. National Mango Board. Project Report Submitted to University of Florida, USA.
- El-Iraqi M.E. ; Y.Sharibim and S.E. El Khawaga (2010). Design and evaluation of mechanical aid tools for mango fruits harvesting. The 17 th Annual conference of misr society of agricultural engineering. Vol. 27, No.(4).
- Hermans V. (2008) . Harvesting fruit. European Commission. DG Employment, Social Affairs and Equal Opportunities.
- Medina J. C. and H.S. García. (2002). MANGO: Post-harvest Operations. Food and agricultural organization of united nation.
- OECD. Organization for economic co-operation and development (2011).International standards for fruits and vegetables, Mango. Trade and agriculture.
- Oida , A. (1997). Using personal computer for agricultural machinery management . Kyoto University. JICA publishing.
- Publication Central Administration for Agricultural Extension, (2004). Cultivation and production of mango. Ministry of agric., Agric. research center. Egypt. No.857.
- Roger C. M. ; J. D. Cataytay; J.A. Aromin and R.F. Tuyogon. (2016).Development of a mechanical mango fruit picker. International symposium on tropical fruits. Philippine council for agricultural resources research and development department. University of southeastern Philippine Tagum-Mabini campus.
- Srivastava A. K.; C. E. Goering; R.P. Rohrbach and D. R. Buckmaster. (2006). Engineering Principles of Agricultural Machines .2nd Edition . American Society of Agricultural and Biological Engineers. (ISBN) 1-892769-50-6.
- Stanford ,J. L. (1993).Circular sawmill and their effective operation. USDA Forest Service State and Private Forestry.
- Stanford ,J. L. (1985).Balanced saw performance. Issue 12 of Technical report (United States. State and Private Forestry. Forest Products Utilization).
- Stanford ,J. L. (1980).How to calculate required horse power for circular saw. Issue 10 of Technical report (United States. State and Private Forestry. Forest Products Utilization).
- Spreer W. and J. Müller.(2011).Estimating the mass of mango fruit (Mangifera indica, cv. Chok Anan) from its geometric dimensions by optical measurement .Computers and Electronics in Agriculture, Volume 75, Issue 1, January, Pages 125-131.
- Thin Kerf Technologies Inc.handbook.(2016). Alignment procedures and instruments for edgers. Precision alignment tools. Publication (2).
- The Arab Organization for Agricultural Development. (2014). Arab Agricultural statistics yearbook VOL. No. (34).
- Theraja, B.L. and A.K. Theraja.(2005).A text book for electrical technology . S.chand &company limited. Vol.(1).
- Wanitchang P. ; A. Terdwongworakul; J. Wanitchang and N. Nakawajana. (2011). Non-destructive maturity classification of mango based on physical, mechanical and optical properties. Journal of food engineering 105 , Pages 477–484.
- Zhenfeng L. ; N. Wang; G.S. V. Raghavan and C. Vigneault .(2009). Ripeness and rot evaluation of ‘Tommy Atkins’ mango fruit through volatiles detection. Journal of Food Engineering . Pages 319–324.

نظام مبتكر لقطف ثمار المانجو

طارق حسين على محمد

معهد بحوث الهندسة الزراعية – مركز البحوث الزراعية – مصر.

تم تصنيع آلة لقطف ثمار المانجو مصنعه من مواد خفيفة مختارة لتكون قادرة على الوصول إلى أماكن الثمار العالية. ويعتمد التصميم المبتكر على قياس مكان القطع الصحيح لطول العنق الثمري لتقليل النزف الصمغي من الثمار، وحماية الثمار من الإصابات و السقوط على الارض . وتتكون آلية القطع من اثنين من المناشير الدائرية يدوران عكس بعضهما نحو الداخل في منطقه القطع لتواجه شفرة حادة ثابتة على طول مركزي دوران منشاري القطع الدائريين. وتم اختيار الآله على ثلاثة أصناف من أشجار المانجو كيت، كينت، وتومي أتكينز وهي من أصناف الأشجار المنخفضة الجذوع وتتميز بحجم الثمار الكبير. وقد تم قياس الأبعاد القصوى للثمار لتصميم وحده القطع وكذا مساحه مقطع العنق الثمري. وتم تجربته أربعة أنواع من المناشير الدائرية على خمس سرعات قطع (٢.٧٨، ٤.١٧، ٥.٥٦، ٦.٩٧ و ٨.٣٤ م / ث . (وأظهرت النتائج أن أقراص القطع المثلى كانت الأقراص المطوره المنشاريه حاده الحافه ذات ١٠٠سنه) عند التشغيل بسرعة خطية بلغت ٨.٣٤ م / ث والتي أعطت نسبة للأعناق الصحيحه القطع بلغت ٩٥٪ و ٥٪ فقط من السيقان المقطوعة أقل من ٥٠ ملليمتر، كما أظهرت النتائج أن الموضع الأمثل للشفرة الثابتة كان تحت الأقراص مع تداخل بين الأقراص بلغ ٥ ملم والذي أعطى نفس نتائج كفاءه القطع. وكانت القدره المحسوبه رياضيا اللازمه لقطع عنق مانجو ثمري بمساحه مقطع ٨٧.٥ ملليمتر مربع تساوى ٣.٥٦ وات وبلغت القدره المقاسه ٤.٨ وات بينما كانت القدره المتوفره من المحركين الكهربيين ٥.٢ وات. كما تم مقارنة تأثير القطف اليدوي بإستعمال عصا ذات خطاف وإستخدام آلة القطف المبتكرة على نسبة تلف الثمار العاليه الموضع. حيث أظهرت النتائج أن متوسط النسب المئوية (الثمار الساقطه على الارض و الثمار المجروحة و الثمار الملوثه بالسائل الصمغي) كانت (١٥.٠٧٪، ٦.٨٥٪، ٣٠.٨٢٪) على التوالي في حاله القطف اليدوي بينما بلغت مع القطف الآلي (٢.٢٨٪ و ٤.٤٣٪ و ٤.٨٦٪) على التوالي. وبلغت التكلفة الإجمالية لتصنيع الآلة ١٥٠٠ جنيه بأسعار عام ٢٠١٧. وبلغت إجمالي تكاليف التشغيل ٢١.٣٧ جنيه / ساعة بينما بلغت القيمة الإيجاريه الميكانيكية للمعدنه ٢٢.٨٢ جنيه / ساعة. وبلغ صافي القيمة الحالية ٨٤٤.٣ جنيه تحت نسبة فائدة بنكيه ١٤٪. وكانت فترة استرداد رأس المال للآله حوالي ١.٣ سنة .