

Direct System for Measuring the Feeding Force and Evaluating the Sewing Parameters.

نظام مباشر لقياس قوة التغذية وتقييم متغيرات الحياكة.

El-Hadidy A., ELDeeb A.S., Hassan M., Mohamed N.

Dept. of Textiles Engineering, Mansoura University, Mansoura, Egypt

المخلص

في هذا البحث تم قياس قوة التغذية على ماكينات الحياكة وتقدير انتظاميتها والتي تعتبر مؤشرا على انتظامية طول الغرزة وذلك باستخدام منظومة حاسب آلي تحت الظروف الفعلية لعملية الحياكة. تلك المنظومة والتي تم إنشائها في هذا البحث تعتمد على طريقة مباشرة في قياس قوة التغذية عن طريق دائرة الكترونية لقياس الانفعال (strain meter). تم دراسة كلا من متغيرات الماكينة المتمثلة في السرعة وحمل قدم الضغط وكثافة الغرز ونوع الدواصة على قوة التغذية وانتظاميتها من غرزه إلى أخرى كما تم دراسة تأثير متغيرات الحياكة المتمثلة في عدد طبقات القماش واتجاه خط الحياكة. أيضا تم دراسة تأثير هذه المتغيرات على مسافة الانزلاق بين طبقات القماش و تم الربط بين انتظامية قوة التغذية وانتظامية طول الغرزة عند زيادة عدد الطبقات أثناء الحياكة وتحت تأثير المتغيرات المختلفة. هذه المنظومة تصلح للاستخدام كوسيلة عملية لتحديد الظروف المثلى لحياكة الأقمشة المختلفة بغرض تحسين الجودة.

Abstract

In this study, the sewing feeding force and its regularity which is an indicator to stitch length regularity were measured using a computer-based measuring systems under the real conditions of sewing process. This system was established to measure the feeding force directly using a gauge piece and a strain meter. The effect of sewing machine setting in terms of speed, presser foot load and stitch density on the feeding force and its regularity from stitch to another were studied. The effect of sewing parameters in terms of number of layers and sewing line direction were also studied. The effect of sewing machine setting on the distance of slippage between fabric layers and the relation between feeding force regularity and stitch length regularity were investigated. The established computer based measuring system could be used as a testing instrument to identify the different ideal sewing parameters for different kinds of fabrics in order to improve the sewing quality.

Introduction:

In this research, the defect of stitch length irregularity is studied. The main reason of this defect is that the fabric actual movement does not match the mechanical motion of the feeding system. This is due to

the slippage which results from the unequal coefficient of friction for the presser foot / upper layer fabric, upper layer fabric / lower layer fabric and lower layer fabric / feed dog. This defect is more visible in

curved lines sewing and in case of moving from two layers to more.

The previous researches are divided into three main trends the first is fabric friction properties, the second is detecting of sewing defects, and the third is parameters affect the stitch length irregularity.

Fabric friction properties:

The effect of fabric structure on friction properties for two groups of fabric. For fabric friction measurements, an instron tensile tester was fitted with an appropriate assembly [1]. The frictional characteristics of several fabric used in apparel were studied. The objective was to generate fabric frictional data to help in developing automated assemblies for fabric [2]. The method of using a laser sensor for measurements of surface roughness and compares the results with those obtained by conventional contact method were introduced [3].

The influence of fabric structure on the stick-slip motion of dynamic frictional force were studied [4]. The experimental results on the sliding of fabric on metallic and polymeric solid surface showing the influence of the compression load at the solid fabric interface and the nature of the solid material [5]. The development of an instrumental method that incorporates some modifications to the basic principles of the method for measuring fabric frictional properties to identify the specific

differences between various kinds of shingosen fabrics [6]. The interpretation of the non-uniform sliding phenomenon response for the dynamic response for sliding friction through dynamic models based on new topographic details of the fabric surface in front of the leading edge of the sled in movement were given [7]. A new generation of sewing equipment integrating auxiliary add on kits to improve performance and flexibility in the production of high -quality garments [8]. The influence of pressing foot design, pressing force the sewing speed upon the stitch length. [9]. The effect of the fabric to metal surface and fabric to fabric frictional characteristics in both warp and weft directions were studied [10].

Parameters affect the stitch length irregularity:

A new generation of sewing equipment integrating auxiliary add on kits to improve performance and flexibility in the production of high -quality garments [8]. The influence of pressing foot design, pressing force the sewing speed upon the stitch length were studied [9]. The influence of selected machine and material parameters on the stitch length and its irregularity were studied [11].

The developing measuring system to measure and analyzes the sewing machine needle penetration torque (NPT) done. The measuring system depended on measuring the change of the electric power under

dynamic conditions by using measuring electric circuit and a digital oscilloscope connected to a [PC] computer [12].

In this research, the measuring system was established to measure the feeding force directly under the real condition of sewing process. The principle of this measuring system depends on using a gauge piece connected to an electronic circuit (strain meter) to measure the tension in the fabric sample which is fed between two sewing machines. The first sewing machine is used to represent the real conditions for friction between fabric and presser foot and the second sewing machine is used to draw the sample under the real

conditions of sewing process in terms of speed, discontinuous motion and vibration. Figure 1 shows a diagrammatical sketch of the established measuring system. The same optical marker was used to determine the start and end of the sewing cycles. As the two signals from the strain meter and the optical marker could be recoded simultaneously on the digital storage oscilloscope, the feeding force could be measured for successive sewing cycles. Regularity of feeding force from stitch to another which is an indication to stitch length regularity could be measured by implementing statistical analysis.

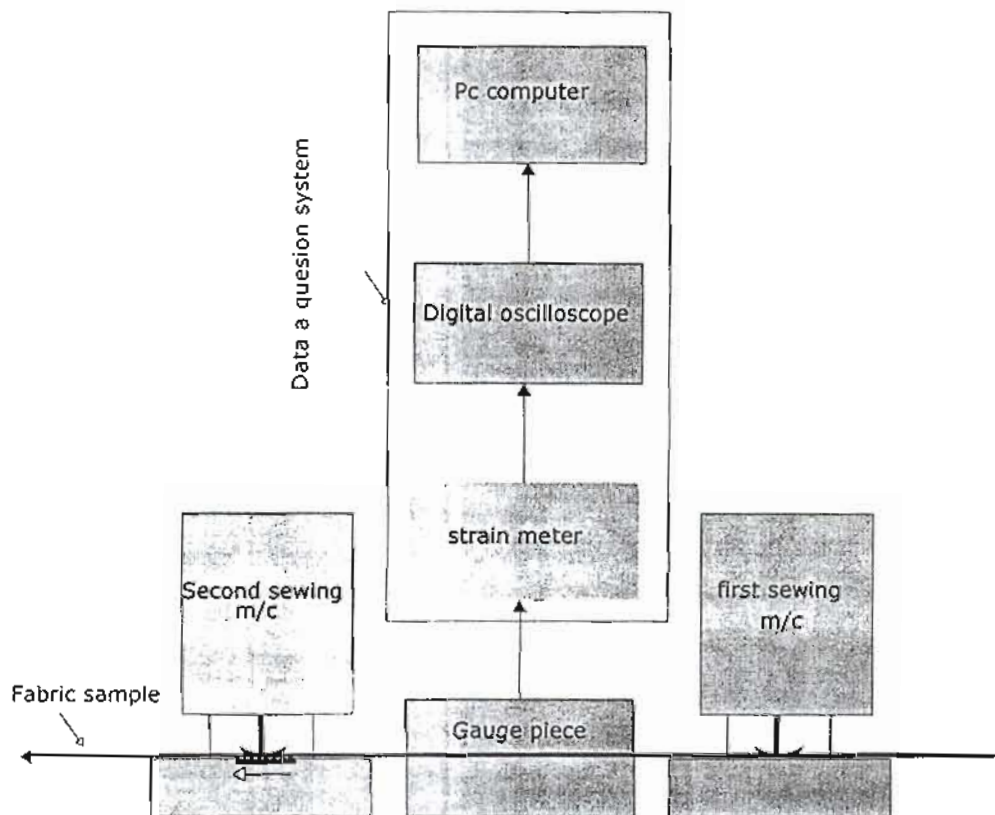

Fig 1 A block diagram for the direct measuring system

1- Sewing machine specifications:

The first sewing machine shown in figure 1 was used only to press the fabric between the presser foot and the throated plat and the feeding mechanism was stopped. The specification of this machine is the same as mentioned in A Pfaff sewing machine was used in the experiments with maximum presser bar lift of 5 mm, maximum speed of 800 s.p.m, 90 watt AC motor and max. presser foot force of 4 kg . The AC motor was replaced by a two-wire, DC Servomotor.

A servomotor is a DC, AC, brushless motor combined with a position-sensing device (e.g. a digital decoder). The servomotor has some control circuits and a potentiometer that is connected to the output shaft. The amount of power applied to the motor is proportional to the distance it needs to travel. So, if the shaft needs to turn a large distance, the motor will run at full speed. If it needs to turn only a small amount, the motor will run at a slower speed. This is called proportional control.

Figure 2 as shows the timing diagram of the sewing machine where it is obvious that feeding starts after 10 degree from the needle bottom position.

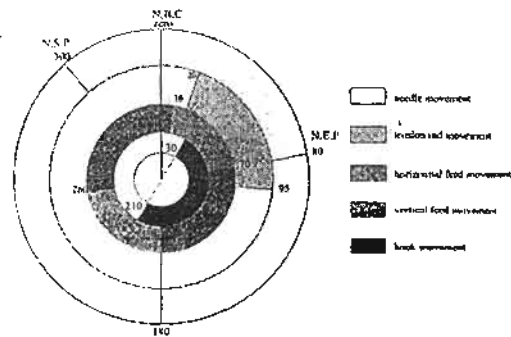

Fig. 2 Timing diagram of the sewing machine (N.S.P Needle Start Penetrate - N.B.C Needle Bottom Center - N.E.P Needle End penetrate)

The second sewing machine shown on figure 1 was used to draw the fabric sample which is loaded by the presser foot load of the first machine and the passed though the gauge piece located between the two machines. Above the pulley of the second sewing machine, the optical marker was fixed as explained in the first measuring system.

2- Gauge piece (sensing element)

The gauge piece which is located between the two sewing machines as shown in figure 1 was composed of a metallic part of stainless steel on the form of channel shape of 60mm length, 40mm width and 0.6 mm thickness as shown in figure 2.

A metallic rod with 8mm diameter is fixed to the channel piece by two screws and is carried by a stand from its two ends to prevent vibration. The fabric sample passes through the distance between the rod and the inner surface of the channel piece according to the 3-pulley system as shown in fig. 4.

Two foil resistance strain gauge of 120Ω were fixed on the inner and outer surfaces of the channel piece by adhesive. Fig.3-3 shows the dimension of the strain gauge.

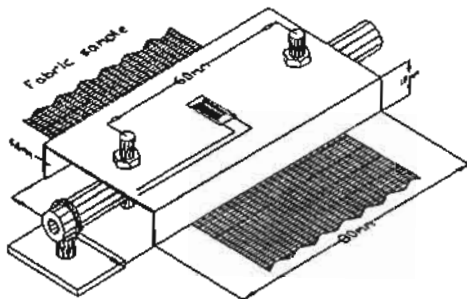

Fig. 2 The gauge piece

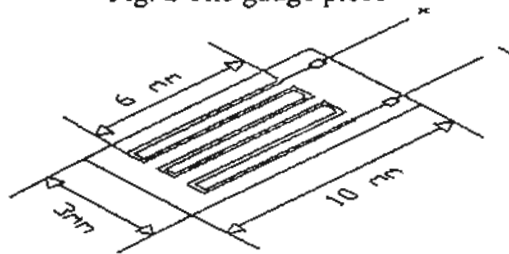

Fig 3 Strain gauge

As shown in fig. 4 increasing the tension of the fabric sample (T) due to the feeding action results in bending stress (F) in the channel piece which will affect on the length of strain gauges. The change in strain gauges length will be converted to change in voltage in the measuring circuit which could be then amplified by strain meter and recorded on the digital storage oscilloscope.

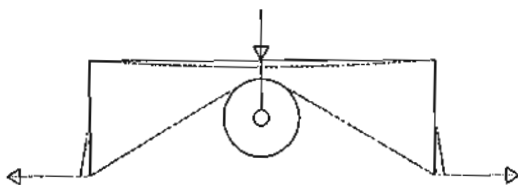

Fig. 4 The stresses on the gauge piece due to fabric feeding

3- Strain meter

Figure 5 shows the strain meter which composed of Wheatstone bridge, amplifier and power supply. The out put of this circuit is recorded simultaneously with the output signal of the optical marker on the two channel of the digital storage oscilloscope which is then analyzed by the computer program.

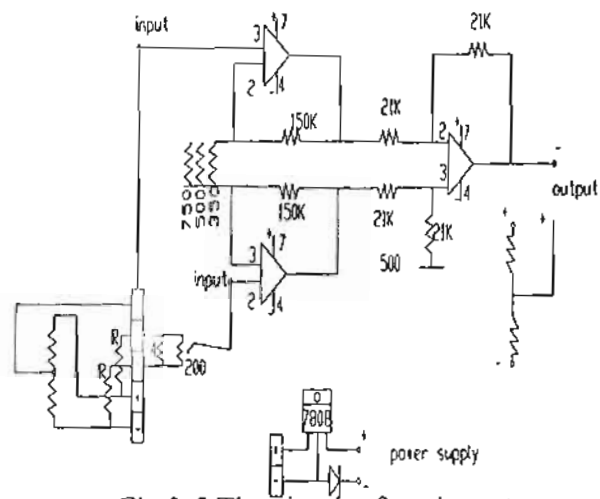

Fig 3-5 The circuit of strain meter

4- Procedures of recording signals

In order to adjust the zero position of the gauge piece before starting of signal recording, the following steps were carried out:

- 1- Convert the oscilloscope to the earth switch and adjust the signal line on the oscilloscope window.
- 2- Convert the oscilloscope to the DC switch which results in changing the position of signal line due to the voltage in the circuit.
- 3- To reset the signal line to the zero position, the resistance of the strain

meter must be changed to obtain the zero volts without any stresses on the stain piece

After that, the second sewing machine could be switching on and signal recording could be started.

5- Estimation of feeding force using the direct measuring system

Figure (6) shows the output signals of the measuring system. The upper signals is the out put of the gauge piece and the lower signal is the output of the optical marker which determine the start and the end of every sewing cycle. In the upper signal the minimum and maximum values between every two successive peaks in the lower signal were determined and the feeding force could be determined for each sewing cycle by subtracting these two values. As this estimated value is an oscilloscope reading (absolute display value), it needed to be converted to a force unit.

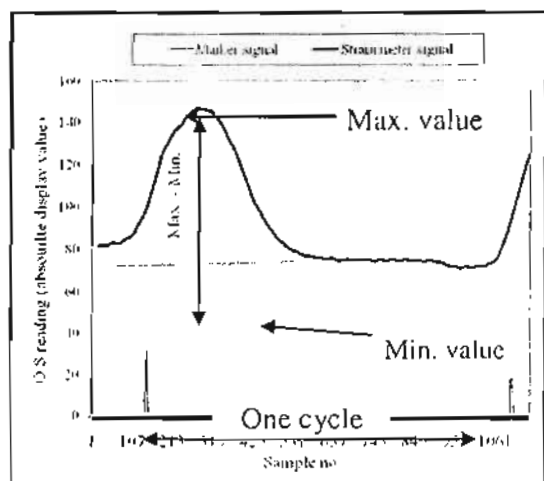

Fig. 6 The output signals of the direct measuring system

6- Sensitivity of the direct measuring system

For testing the Sensitivity of the established measuring system, signals were recorded at different levels of machine speed, presser foot load and stitch density. Figure (7) shows the recorded signals at three levels of presser foot load minimum load, medium load and maximum load at constant machine speed and constant stitch density. It is obvious that the established measuring system is sensitive to the change in presser foot load.

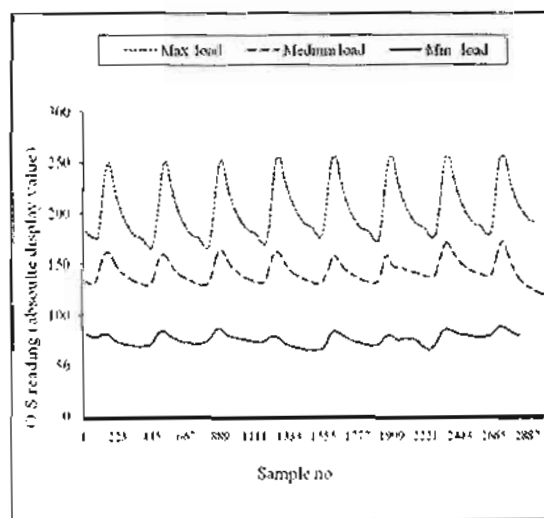

Fig. 7 Sensitivity of the direct measuring system for different presser foot loads

Figure (8) shows the recorded signals at three levels of stitch length (1.8, 2.5 and 4.5 mm) at constant machine speed and presser foot load. It is obvious that the established measuring system is also sensitive to the change in stitch length.

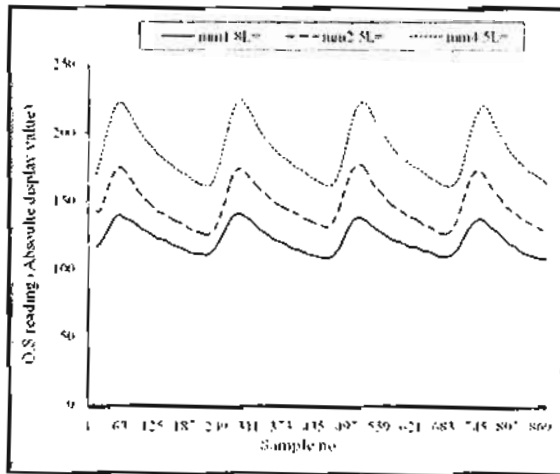

Fig. 8 Sensitivity of the direct measuring system for different stitches length

Figure (9) shows the recorded signals at three levels of machine speed (111, 281 and 745 s.p.m) at constant stitch length and constant presser foot load. The result shows that the established measuring system is sensitive to the change in machine speed.

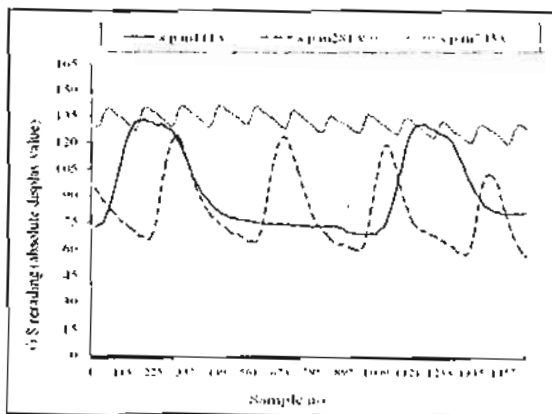

Fig. 9 Sensitivity of the direct measuring system for different machine speed

3-7 Calibration of gauge piece

In order to convert the absolute display values of the digital oscilloscope to force unite (CN), static and dynamic calibration were executed. The dynamic calibration was executed on the sewing machine under the

real condition by feeding the fabric sample with sewing machine and using weights on the other end. Signals of 50 successive sewing cycles were recorded for each weight.

Figures (3-10) show the curve that represents the relation between the absolute display values of the digital oscilloscope and the force (gm) which was then converted to (CN). The calibration factor was determined from the curve as 28.54 CN per oscilloscope reading value. The dynamic calibration was found to be more accurate and thus the dynamic calibration factor was used.

Calibration factor = $(500-108) / (22-8) = 28$
 gm/O.S value = 28.54cn/o.s unite.

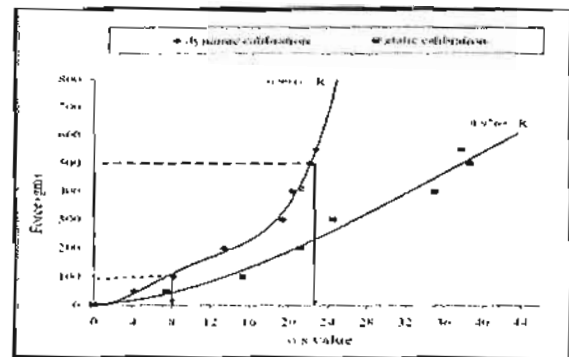

Fig. 10 Calibration curve of gauge piece

The signals were recorded and then analysis by the same MATLAB program used in analysis signals of the first measuring system as shown in figure (11)

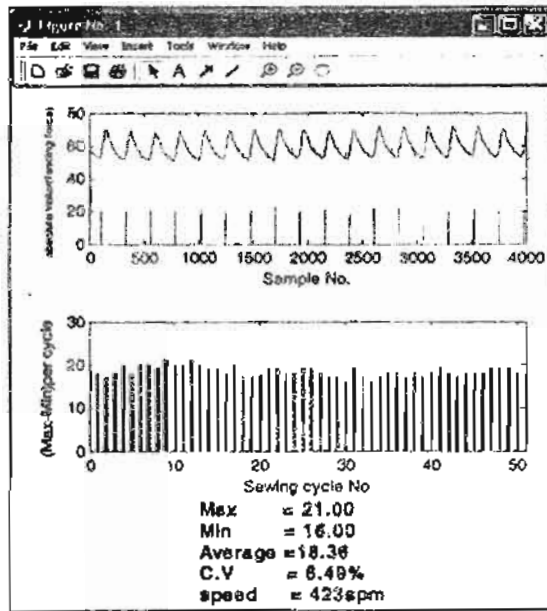

Fig. 11 The out put of the MATLAB program

8 Experimental work for the direct measuring system

After establishing the measuring system and testing its sensitivity, the experimental work was planned to study the effect of machine setting (speed, stitch density, presser foot (load, width, and material) , feed dog tooth and fabric parameters (number of layers and sewing direction)on feeding force and its regularity. Also, the effect of machine setting on the distance of slippage between fabric layers was studied. The final part of the experimental work was planned to correlate the feeding force regularity and the stitch length regularity. Tables 3-1 show the specifications of the fabric samples.

Table (1) Fabric specifications

Warp count	24 Ne
Weft count	20 Ne
Type of fabrics	100 % cotton
Fabric density	24/cm x 20/cm
Weight / unit area	128.12 g/m ²
Width	220 cm
Fabric structure	Plain

8-1 Effect of machine setting.

This experiment was planned as shown in table (table 2). Signals were recorded at five different levels of each variable so the total number of signals was 125. In this experimental a presser foot of medium width was used. Signals were then analyzed to estimate the average of feeding force for 50 successive sewing cycles in each signal.

8-2 Effect of presser foot width:

In order to study the effect of presser foot width on feeding force and its regularity, three presser foot of different width were used and the signals were recorded at different levels of stitch density, machine speed and at constant presser foot load 1.9 (KG) as shown in table (3).

8 -3 Effect of presser foot material

In order to study the effect of presser foot material on feeding force and its regularity, two presser foot of different materials were used and the signals were recorded at

different levels of stitch density, machine speed and at constant presser foot load 1.9 (KG) as shown in tables (3-4).

8-4 Effect of feeding dog position.

In the previous experiments, the feeding dog was stopped and the fabric was pressed between the presser foot and throat plate.

In order to study the effect of feeding dog tooth on feeding force and its regularity, singles were recorded with stooping the feeding dog and with the feeding dog fixed in the upper position. As shown in table (3-5) singles were recorded at 5 different levels of stitch density and 3 different levels of machine speed and constant presser foot load 1.4 kg in each case.

8-5 Effect of sewing parameters.

8-5 -1 Sewing direction

In order to study the effect of sewing line direction on the feeding force and its regularity, singles were recorded when the fabric was sewed in weft direction, warp direction and at 45 degree with 5 different levels of stitch density as shown in table (3-6), at constant medium load (1.9 kg) and constant medium speed (574 s.p.m), using metallic presser foot of medium width.

8-5-2 Number of layer

In order to study the effect of no. of layers on the feeding force and its regularity, singles were recorded when two, three and four layers were used with 5 different levels of

stitch density as shown in tables (3-7), at constant medium load (1.9 kg) and constant medium speed (574 s.p.m).

8-6 Effect of machine setting on fabric slippage between two layers

In order to study the slippage between fabrics layers, two fabric layers of length 1 m were fed to the system without the aid of hand feeding which considered as one of the causes for stitch length irregularity. Singles were recorded at 5 different levels of stitch density, 3 levels of speed and two levels of presser foot load. The low level of the load was the weight of the presser bar (90 gm) as shown in table (3-8).

8-7 The relationship between feeding force and stitch length regularity

In order to study the relationship between feeding force and stitch length regularity 4 experiments were planned to study the following

- 1- The effect of increasing number of layers during sewing from 2 to 3, from 2 to 4 and from 2 to 5 layers at constant machine speed (732 s.p.m), constant presser foot load (500 gm) and at constant stitch density (3.5 s.p.cm).
- 2- The effect of increasing machine speed (421 , 578 and 732 s.p.m) when the number of layers is increased from 2 to 4 during sewing at constant levels of presser foot load (500 gm) and constant stitch density (3 s.p.cm).

3-The effect of increasing presser foot load (240, 381 and 500 gm) when the number of layers is increased from 2 to 4 during sewing at constant levels machine speed (578 s.p.m) and constant stitch density (3 s.p.cm).

4-The effect of increasing stitch density (2.5, 3 and 3.5 s.p.cm) when the number of layers is increased from 2 to 4 during sewing at constant levels machine speed (732 s.p.m) and constant presser foot load (500 gm).

In order to measure stitch density, a paper was fixed on the denim fabric sample during sewing and after that an image of this paper was captured and magnified by scanner (hp scan jet 2400), in order to measure the length of stitch accurately because the paper retains the effect of needle penetration which may be changed in the fabric due its elasticity.

9 Results and Discussion

9-1 Effect of machine setting using the direct measuring system

Figure (12) shows that the feeding force decreases with increase of machine speed at all levels of stitch density and at load of medium value (1.9) kg.

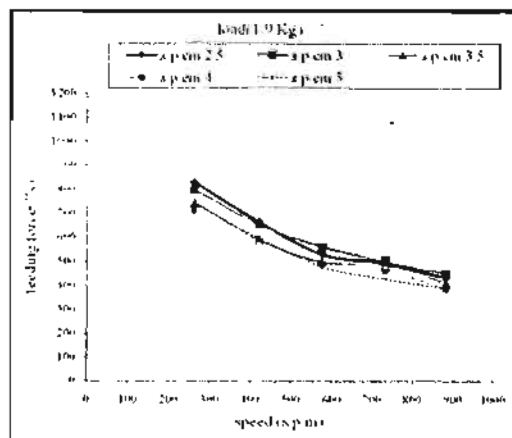

Fig. 12 Effect of speed at different stitch density and medium load.

The same trend was found at high and low load values 2.5 kg and 1.4 kg respectively shown in fig. (13) and at very high and very low load value 3 kg and 0.9 kg respectively as shown in figure (14).

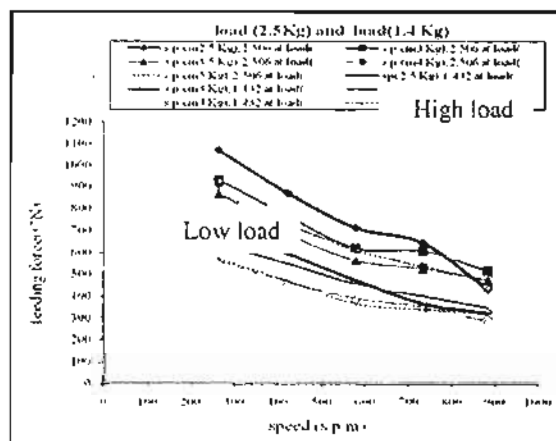

Fig. 13 Effect of speed at different stitch density and high and low load.

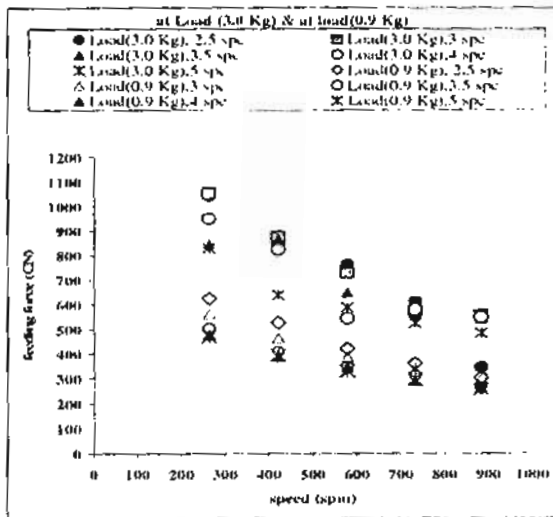

Fig. 14 Effect of speed at different stitch density at very high and very low load.

Figure (15) shows that feeding force increase with the increase of presser foot load (from 0.9 to 3 kg) at all levels of machine speed (from 263 s.p.m to 883 s.p.m).

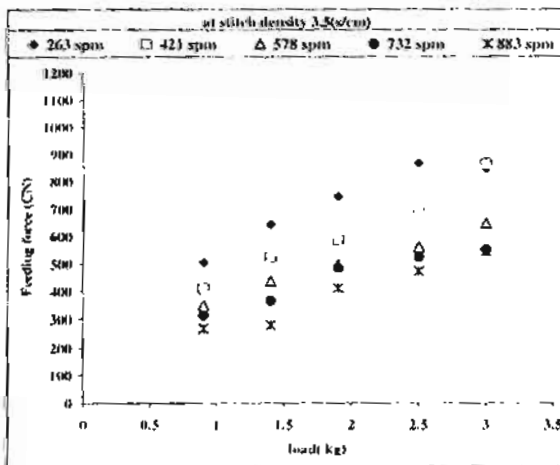

Fig. 15 Effect of presser foot load at different speed

9-2 Effect of presser foot width.

Figure (16) shows the effect of presser foot width on the feeding force at 573 s.p.m respectively. As shown from these figures, the minimum value of feeding force was found with the medium width of presser foot at all levels of stitch density.

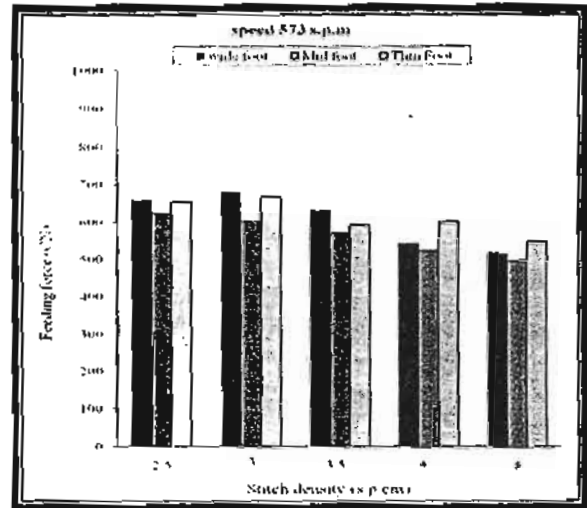

Fig. 16 Effect of presser foot width at 573 s.p.m.

9-3 Effect of presser foot material.

Figure (17) shows the effect of presser foot material (metal and plastic) on feeding force at 573 s.p.m respectively. As shown from this figure, the feeding force was changed with the different material of presser foot because the coefficient of friction between fabric and presser foot is different. Also, it is clear that the feeding force decreases in case of using metal presser foot.

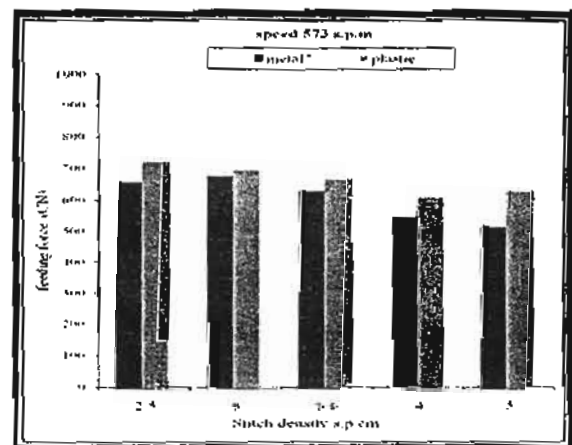

Fig. 17 Effect of presser foot material at 573 s.p.m

9-4 Effect of feeding dog position.

Figure (18) shows that the feeding force increases in case of fixing the feeding dog in the upper position with all levels of stitch density. This could be explained by the interlacing between feeding dog tooth and the fabric.

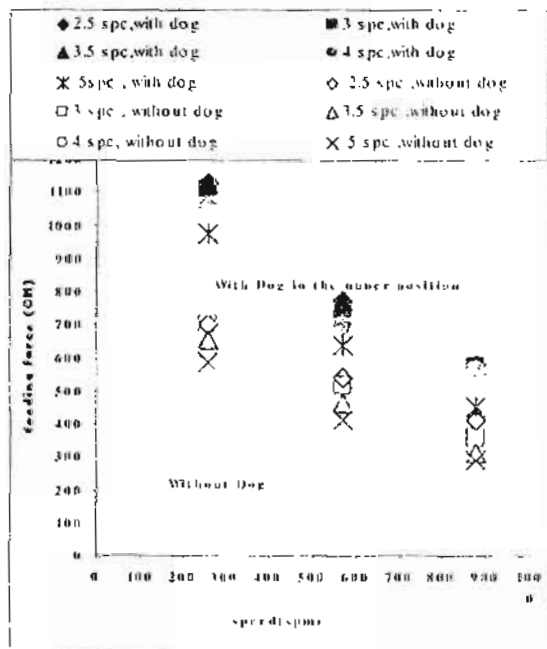

Fig. 18 Effect of feeding dog tooth on the feeding force.

9-5 Effect of sewing parameters.

9-5-1 Effect of sewing direction

As shown from figure (19), at all levels of stitch density, the maximum feeding force when the fabric was sewed in warp direction and minimum when the fabric was sewed at 45 degree.

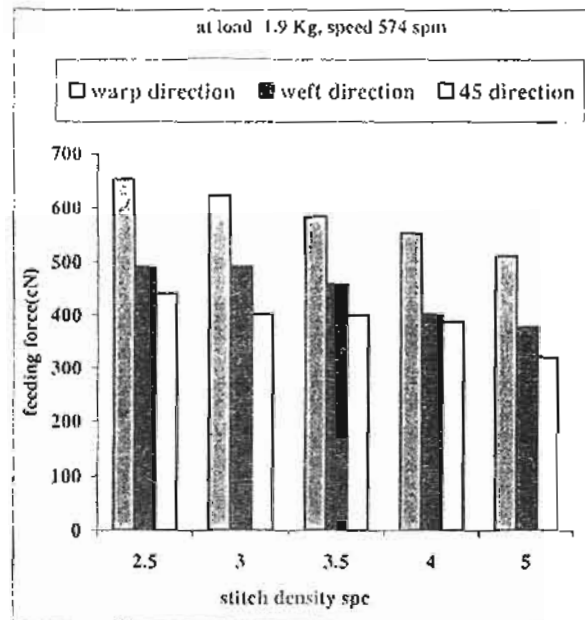

Fig. 19 Effect of sewing fabric direction on feeding force.

9-5-2 Effect of number of layers

From figure (20), it is obvious that feeding force increases when the number of fabric layers increases which may be interpreted by the increasing of presser foot load.

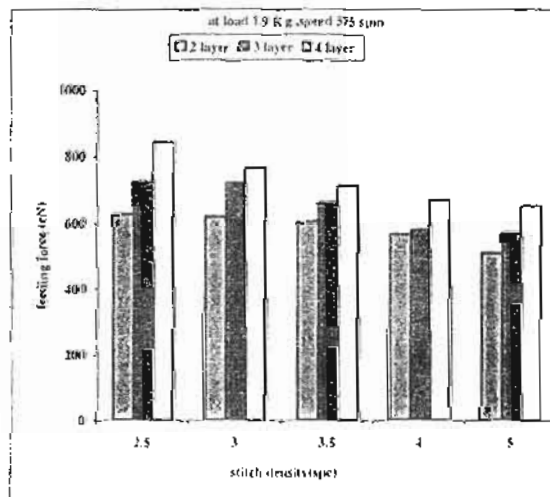

Fig. 20 Effect of no. of layers on feeding force.

9-6 Effect of machine setting on fabric slippage between two layers.

Figure (21) shows that the slippage distance at high load between the two layers increases with the increases of machine speed at all levels of stitch density. At all level of machine speed, the minimum distance of slippage was found at 3 s.p.cm and it is increased obviously at 2.5 s.p.cm.

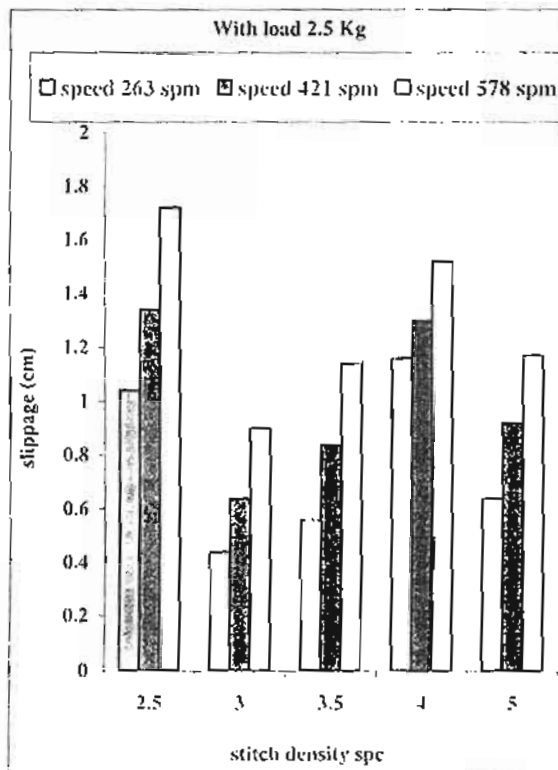

Fig. 21 Slippage distance between fabric layers at different stitch length and high load (2.5 kg)

Figure (22) shows that with the low load (90gm), the slippage distance also increased with the increases of machine speed at most levels of stitch density but there is obvious increased at 3.5 s.p.cm. and at 2.5, 5 s.p.cm the slippage distance decreased.

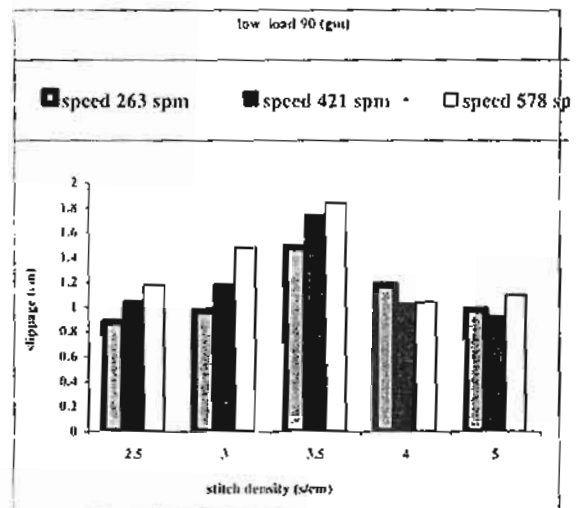

Fig. 22 Slippage distance between fabric layers at low load (90 gm)

10 Relationship between feeding force and stitch length regularity

10-1 Effect of increasing no. of Layers during sewing

Figure (23) represents (a) the image of the paper, (b) the recorded signal and (c) the estimating feeding force on the left y axis (line curved) and the measured stitch length on the right y axis (columns) for each numbered from 1 to 27. The no of layers increased from 2 to 3 starting from stitch no. 21 to 27 in this signal and as shown the feeding force increased from 399 to 570 (CN) and the stitch length decreased from 2.6 to 2 mm when the no. of layer increased.

Figure (24) shows that when the no of layers increased from 2 to 4 starting from stitch no. 18 to 25, the feeding force increased from 314 to 599 (CN) and the stitch length decreased. This signal was recorded at stitch length of 2.9 mm but the actual measured length was 2.5 mm maximum this means that found slippage in stitch length than required value. The minimum value of stitch length is

1.5 mm at the start of moving from 2layer to 4 layers (stitch no. 18)

Figure (25) shows that when the no of layers increased from 2 to 5 starting from stitch no. 13 to 25, the feeding force increased from 342 to 827 (CN) and the stitch length decreased from 2.6 to 1.4 mm. From the three figures (40), (41) and (42) it is obvious that the maximum increase in feeding force and maximum decrease in stitch length were found in case of increasing layer number from 2 to 5 layers.

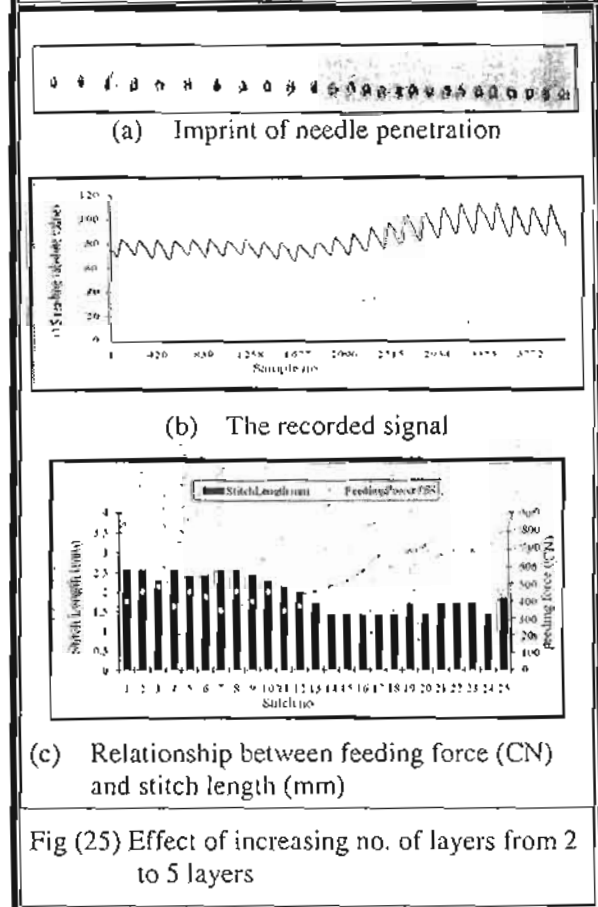
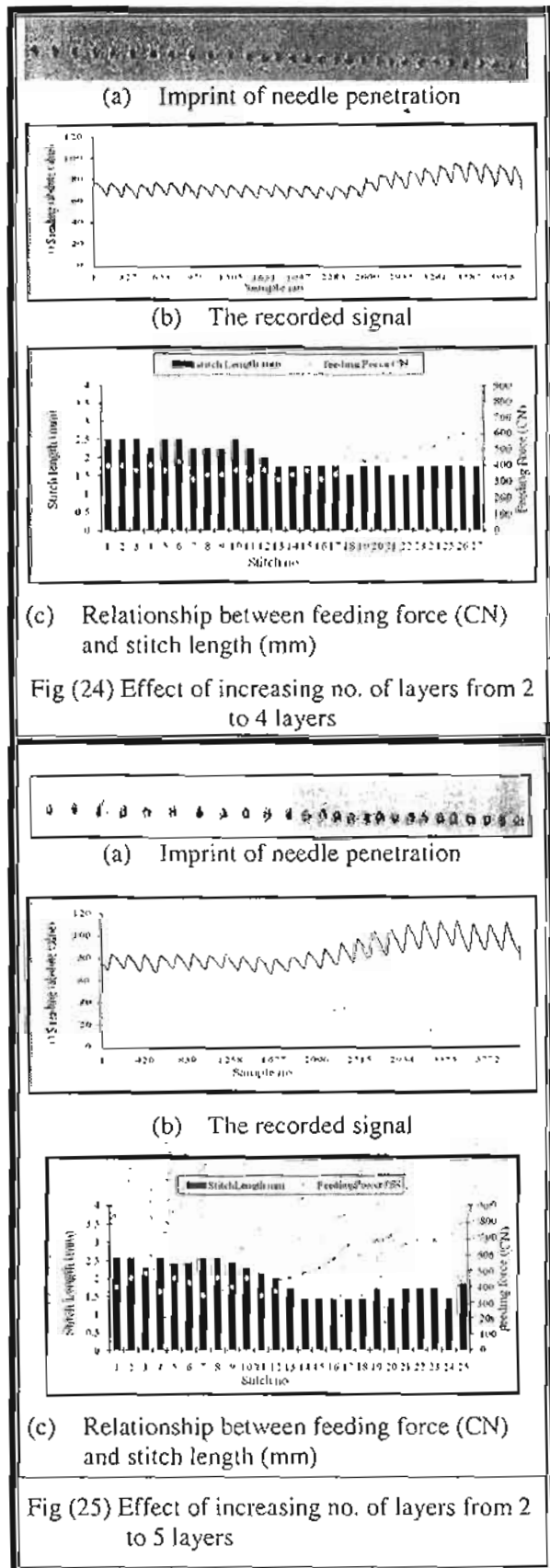
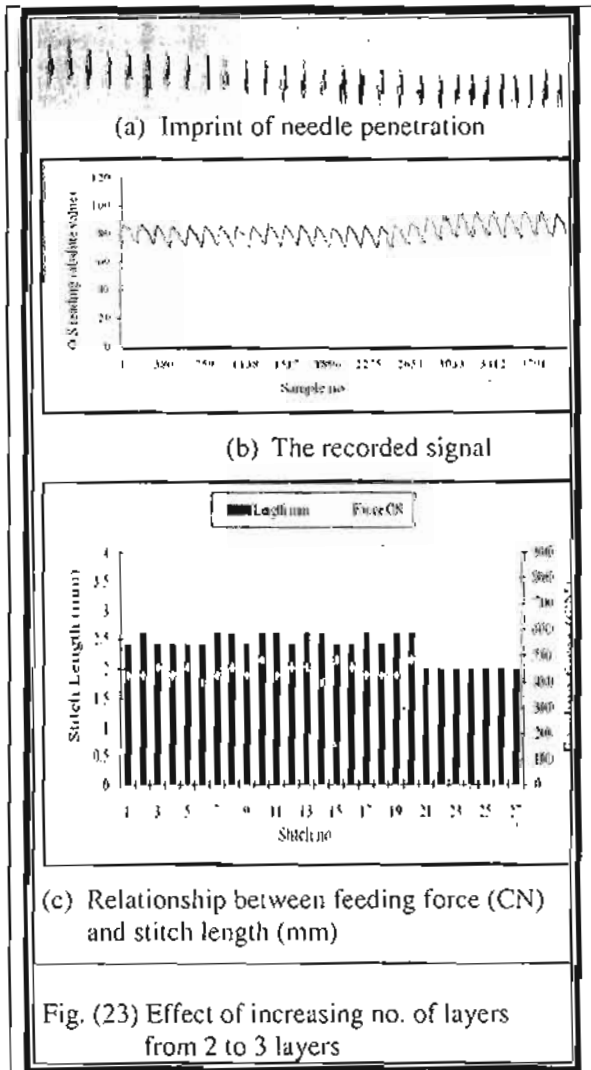

10-2 Effect of increasing machine speed during sewing on the relation between feeding force and stitch Length regality

Figure (26) shows that, at 578 s.p.m when the no of layers increased from 2 to 4 layers starting from stitch no. 11, stitch length decreased from 3.6 to 2.4 mm at this point, and after that it begins to increase. The feeding force also increased from 456 to 713 (CN).

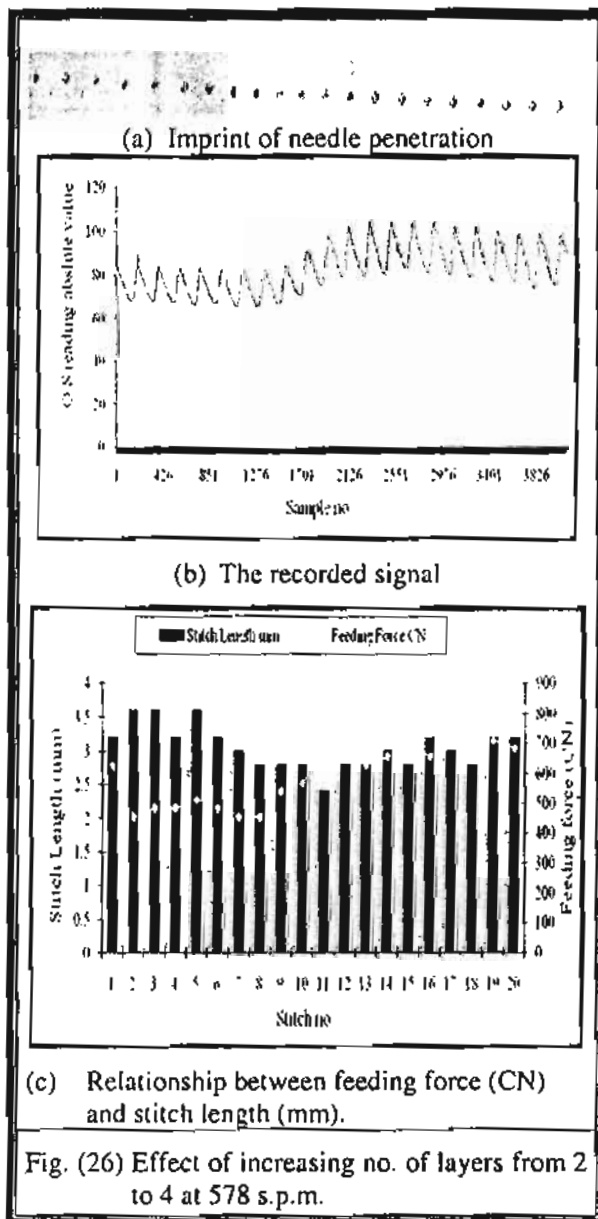

10-3 Effect of increasing presser foot load during sewing on the relation between feeding force and stitch Length regality

Figure (27) shows that, at presser foot load of 381 gm , stitch length 3.3 mm when the no of layers increased from 2 to 4 layers starting from stitch no. 13, stitch length decreased from 3.4 to 1.7 mm and the feeding force increased from 428 to 770 (CN).

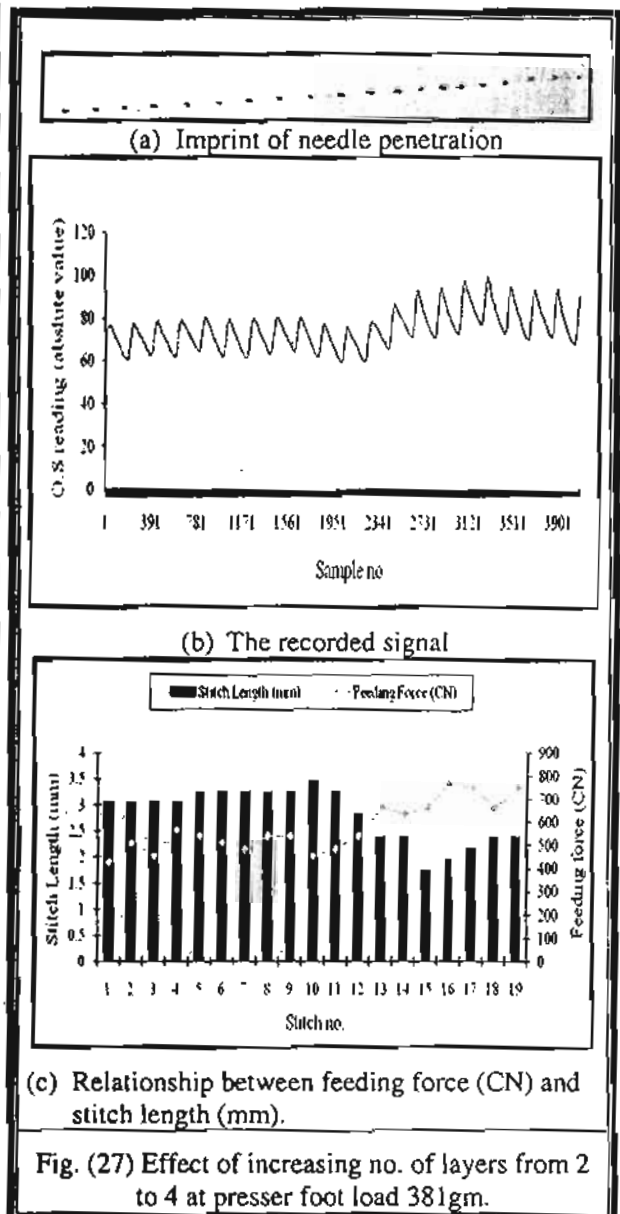

10-4 Effect of increasing stitch density during sewing on the relation between feeding force and stitch Length regality

Figure (28) shows that, at stitch density 3 s.p.cm (3.3 mm), when the no of layers increased from 2 to 4 layers starting from stitch no. 17, stitch length decreased from 3 to 1.3 mm and the feeding force increased from 342 to 713 (CN).

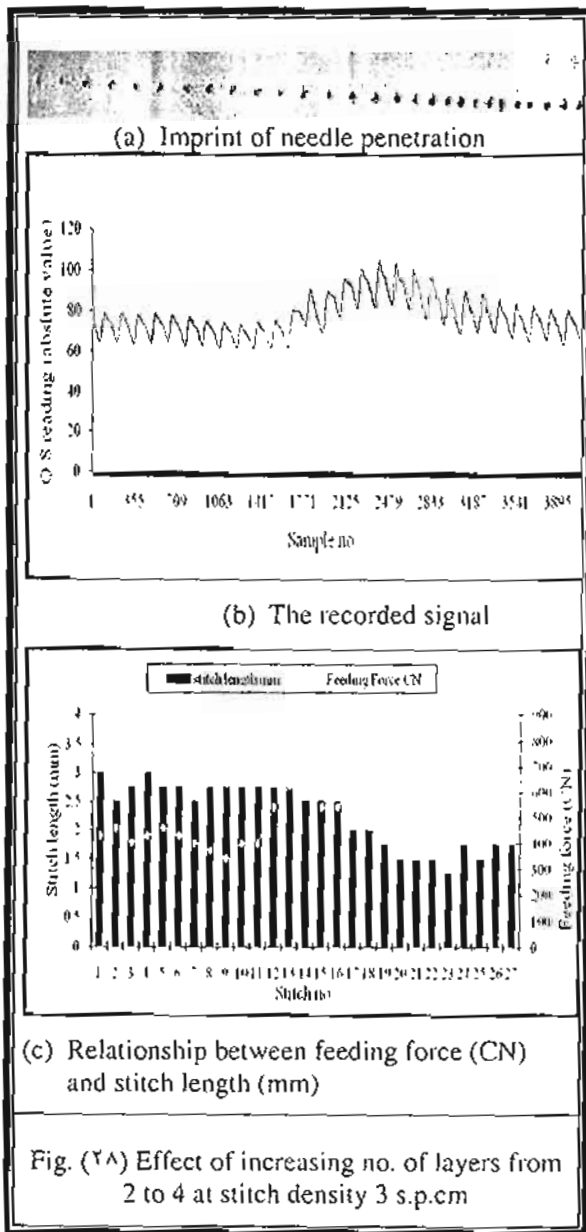

11. Conclusion

From studying the previous parameters it is clear that regularity of feeding force is an indication of stitch length regularity.

Apply a pervious computer based system with doing some modifications and also establishing a new computer based system to measure the regularity of the feeding force.

The results from both systems agreed with the previous research done by Vobolis and juciene (2003, 2004) with using different system.

By getting a relationship between the feeding force and the stitch length irregularity, so we could predict from the feeding force irregularity the stitch length irregularity.

We could use our computer-based system as a testing instrument to identify the different ideal sewing parameters with different kind of fabrics (sewing speed, density, the load of presser foot, and the presser foot type).

Finally by using our new measuring system we could improve the sewing quality instead of correct the sewing defects after their accrued to decrease the product defects (reduce the second quality). By doing this research reach its main gale which is finding the way to predict the regularity stitch length before the production line with comparing the feeding force coefficient of variation by using our computer-based system.

References

- [1] Carr, J.E.Posey, and W.C.Tincher, "Frictional Characteristics of Apparel Fabrics" Textile Research Institute, pp.129-136, March 1988.
- [2] Joseph O. Ajayi, "Effects of fabric structure on frictional properties" Textile Research Institute, , pp.87-93, February 1992.
- [3] R.B.Rangulam, J.Amirbayat, and I.Porat, "Measurement Of fabric Roughness by a Non-contact Method" Textile Institute, 84 (1), pp. 99-106, 1993.
- [4] Hosseini Ravandi S.A., Toriumi K. and Matsumoto Y., "Spectral Analysis of the stick -slip Motion of Dynamic Friction in the Fabric surface ", Textile Research Journal, 64 (4), pp. 224-229, 1994.
- [5] Luis Virto and Arun Naik " Frictional Behavior of Textile Fabrics - part I: sliding phenomena of Fabrics on Metallic and polymeric solid surfaces ", Textile Research Journal. 67(11), pp. 793-802, 1997.
- [6] Matsuo T., Okamoto F., Akiyama R. and Mukhopadhyay S.K., "A study of the relationships between the surface properties, hand and structure of shingosen fabrics" Textile Institute, 91 (1) (1), pp. 78- 91, 2000.
- [7] Luis Virto and Arun Naik " Frictional Behavior of Textile Fabrics - part II: Dynamic Response for Sliding Friction ", Textile Research Journal, 70 (3), , pp.256-260, 2000.
- [8] Luis F. Silva, Helder carvalho and Filomena Soares "Improving feeding efficiency of a sewing machine by on-line control of the presser foot ", IEEE International Conference on Industrial Technology (ICIT), pp. 990, 2004
- [9] M.Juciene and J.Vobolis " Influence Of Fabric External Friction Force and Certain Parameters of a Sewing Machine Upon Stitch Length ", ISSN 1392-1320 Material science , 10 (1), , pp.101-104, 2004.
- [10] Apurba Das, Kothari V.K. and Nagaraju Vandana "A Study On Frictional Characteristics Of Woven Fabrics", AUTEX Research journal, 5 (3), pp.133-140, September 2005.
- [11] Vobolis J., Juciene M., Punys J., Vaitkevicius V. "Influence Of Selected Machine and Material Parameters on the Stitch Length and Its Irregularity", Fibres And Textiles In Eastern Europe , , 11 (3) (42), pp. 50-55 July/September 2003.
- [12] Abd El-Salam D. " Study the effect of fabric and Sewing Machine Parameters on the Dynamic Behavior of Sewing" M.Sc. Mansoura University, 2004.