

ENHANCING FORCED CONVECTION HEAT TRANSFER IN ANNULAR TUBES BY USING ALUMINUM MESH LAYERS

تمكين انتقال الحرارة بالحمل القسري في أنابيب حلقية باستخدام طبقات شبكية من الألمنيوم

AHMED A. SULTAN and GAMAL I. SULTAN

Mechanical Power Department, Mansoura University
Faculty of Engineering, El-Mansoura, EGYPT

خلاصة:

يتضمن هذا البحث دراسة عملية للفقد في الضغط وانتقال الحرارة بالحمل القسري لتيار هوائي مضطرب يري في رابع حلقي أسطواني، الأنبوبة الداخلية مصنوعة من الألمنيوم بقطر خارجي 24.2 مم مسخنة من الداخل بفيض هوائي مضطرب، الأنبوبة الخارجية مصنوعة من البلاستيك (PVC) بقطر داخلي 48.1 مم ومعزولة من الخارج بطبقة من العنبر الزجاجي، تلف طبقات شبكية من ألياف الألمنيوم الرقيق " فلتر الهواء لجهاز تكييف الشباك " ملفوفة على السطح الخارجي للأنبوبة الداخلية بسمك متغير لدراسة تأثير سمك الطبقة على كل من فقد الضغط وانتقال الحرارة، يتغير رقم رينولدز خلال الدراسة بين حوالي 3000 آي 20000 بينما تتغير نسبة سمك الطبقة الشبكية آلي سمك الفراغ الحلقي عن 0.1925 إلى حوالي الواحد. وأوضحت الدراسة أن معامل انتقال الحرارة محسوبا على مساحة سطح الأنبوبة الداخلية يزداد بزيادة كل من رقم رينولدز وسمك الطبقات الشبكية وتراوح الزيادة بين 80 إلى 270٪، بينما يزداد معامل الاحتكاك بزيادة سمك الطبقات الشبكية وتقصان رقم رينولدز وتراوح الزيادة بين 114 آي 10680٪. وقد نحى أداء المبادل الحراري على أساس ثبات قدرة الضخ ومساحة سطح انتقال الحرارة وتراوح الزيادة في كمية الحرارة المستقبلة " رقم نوسلت " بين 29 آي 420٪، كما تم حساب الأداء على أساس ثبات كمية الحرارة ومساحة سطح انتقال الحرارة ووصل الانخفاض الأقصى في القدرة حوالي 76٪، وبدراسة فعالية المبادل الحراري لانتقال الحرارة ككل وجد أن الطبقات الشبكية ذات النسبة (1/8) تساوي 0.1925 أكثر فاعلية من الطبقات الأخرى. وقد تم صياغة النتائج العملية في معادلات تجريبية لإمكانية استخدامها في حساب معامل انتقال الحرارة والاحتكاك.

ABSTRACT

An experimental investigation of heat transfer and pressure drop for turbulent flow of air in an annular tube of 48.1 mm outside diameter and 24.4 mm inside tube diameter are conducted. The inner tube, which is made of polished aluminum, heated under constant heat flux and wound by aluminum mesh-layers, while the outer tube is made of plastic (PVC) and insulated from outside with glass wool. Mesh-layers are used as an augmentative device with different thickness ($2.3 \leq t \leq 11.9$ mm). Reynolds number varied between 3000 and 20000 and Prandtl number was about 0.7. Friction factor are found to be 2.14 - 106.8 times the empty annular tube values, while Nusselt number are found to be 1.8 - 3.7 times the empty annular tube at the same Reynolds number. The Nusselt numbers are found to be 1.29 - 5.2 times the empty annular tube values based on constant pumping power and constant basic geometry. When compared with empty annular tube at constant heat duty and constant heat transfer area,

a maximum reduction in pumping power of 76% can be achieved with augmented annular tubes. It is concluded that the use of this class of augmentative device is generally more effective for the case when mesh-layers thickness (t) is nearly equal to 2.3 mm ($t/\delta = 0.1925$, where δ is annular gap thickness). Finally, correlations are developed for the prediction of friction factors and Nusselt number.

Introduction

Recently, convective heat transfer in porous media has an important application in geophysics, biomedical, agricultural engineering and many industrial applications. These applications include the following: porous journal bearing, nuclear waste disposal, porous flat plate collectors, packed bed thermal storage, fibrous insulation, grain storage and drying, paper drying and food storage, heat exchangers, oil production, electronic cooling, heat pipes, filtration, and chemical reactors.

A review of the related literature shows that most of the previous studies treated the annular geometry completely filled with porous material and studied the natural convection heat transfer mode [1-4]. Different numerical methods were used to study the operating parameters such as Rayleigh number, porosity, and aspect ratio on the heat transfer characteristics. Sultan and El-Shafei [5] investigated experimentally the local heat transfer of water flowing through vertical tube packed with spherical steel particles of different diameters. The tube is heated electrically with a constant heat flux while Reynolds number is varied. Clikh et al. [6] through using Darcy-Binkman model, an analytical solution was obtained for forced convection in an annular duct partially filled with porous medium. The inner tube is exposed to a constant heat flux and the outer is thermally insulated. The effect of the permeability, thermal conductivity, and thickness of the porous material are investigated. Fowler and Bejan [7] investigated numerically the heat transfer, friction, and mechanical interaction between external laminar perpendicular flow and a solid surface covered by a layer of fibers. They found that at porosities lower than a critical value, the fiber cover acts as insulation, while at higher porosities the fibers augmented the heat transfer. El-Nimr and Alkom [8] presented a numerical solution of transient, developing, forced convection flow in concentric annuli partially filled with porous substrates. The effect of geometry, solid matrixes metal and the fluid on the hydrodynamic and thermal behavior was investigated. They found that porous substrates might improve Nusselt number by 1200% while keeping other flow and geometrical parameters fixed. Peterson and Chang [9] through an experimental work studied two-phase heat dissipation in high conductivity porous channel heat sinks. They used sintered copper particles inside a rectangular copper channel as a porous material, subcooled water as a working fluid, flow rate is changed, and its subcooling is varied. Numerical computations were performed for laminar flow with high porosity media composed of small diameter silicon, carbon fibers aligned transverse to the streamwise flow specifically flow over a backward facing step by Martin [10]. El-Kady [11,12] studied experimentally the effect of partially filling porous medium with localized discrete heat source attached to the bottom wall of a horizontal channel and operating parameters (Re , Gr , and q) on heat transfer characteristics.

From the above review it's concluded that there were a very little literature dealt with forced convection through annulus filled with porous material. So, the aim of the present work is to investigate the enhancement of forced convection in an annulus partially filled with a porous aluminum mesh layers. The effect of different parameters, such as the mesh layers thickness and operating parameters on Nusselt number are investigated.

Experimental Apparatus

A schematic diagram of the experimental setup is shown in Fig.1-a. It consists of a centrifugal blower (17) connected from its suction side to the test section outlet through a flexible connection (16) to avoid transmission of blower vibration to the test tube. The inlet side of the test tube stabilizing section (4) is connected to a bell mouse connection (1) provided with fine screen (2) to ensure fairly uniform flow of air. A graduated opening (15) is used to control the airflow. The air velocity is measured in a section free of the porous media (4) by a hot-wire anemometer (3) in both X and Y direction and integrated to obtain the mean inlet velocity. The test section consists of two-concentric tubes each of length 1980 mm, the outer tube (14) has an inside diameter of 48.1 mm was made of plastic (PVC). The inside tube of the annulus (7) is made of aluminum with outer diameter of 24.2 mm. It consists of two sections: the heated section of length 980-cm, and the unheated one of length 1000-mm and is separated by a Teflon connection (8). It is placed inside the outer tube in a symmetrical position by the help of three groups each consists of three fine threaded bolts (6). Each group consists of 3 bolts of 3 mm diameter at 120° to form a uniform annulus, one at both ends and the third one at the middle section. The unheated section is covered at the front end by a hemispherical Teflon smooth end (5) to ensure no chock of air stream. An entrance length (4) upstream of the test section with a length of approximately 40 hydraulic diameter is used for the redevelopment of the flow which is necessary for the pressure drop and heat transfer measurements. Two static pressure taps (9,13) were provided at inlet and outlet from the heated section. Pressure drops are measured in the cases of porous and non-porous annulus by means of digital micro-manometer (10) with an accuracy of ± 1 Pa. The heated section of the inner tube of the annulus is heated by a helical Nickel-Chrome wire (18) as shown in Fig.1.b. It is placed in a glass tube (20) of diameter 12-mm. The glass tube is filled with fine sand particles (19) and is closed at both ends by gypsum and inserted inside the inner tube of the annulus. The gap between the glass wall and the inner surface of the aluminum tube is filled with aluminum powder (21) in order to insure uniform distribution of heat and prevent the heater from burning up. The inner tube of the annulus of the heated section is wound with aluminum mesh layers (12) to study the effect of mesh-layers thickness on both pressure drop and heat transfer characteristics. The test section was well insulated with fiber glass wool (11). The air temperature at inlet and outlet of the test section are measured by using two copper-constantan thermocouples of type (J) and the air properties are calculated as a function of the average air temperature. The radiative heat losses from the porous media to the inner surface of the outside tube in the case of porous annulus tends to be zero because of the very small diffusivity of polished aluminum. An autotransformer is used to control the heat input to the heat source, which was measured by an ammeter and voltmeter. The surface temperature of the inner tube of the annulus is measured by 7 copper-constantan thermocouples, and another 7 copper-constantan thermocouples are glued on the inside surface of the outer of the annulus tube corresponding to those fixed on the outer surface of the inside tube. The temperature signals are then transferred to a digital temperature recorder (Yokogawa) of a sensitivity of 0.1 °C. The porosity, ϵ , was evaluated using the expression, $\epsilon = (V - V_s) / V$, where V is the volume of the channel occupied by mesh-layers and V_s is the volume of mesh-layers (determined by dividing the weight of the mesh-layers by its density). This porosity is about the value of 0.91. Nearly one hour was needed to reach the steady-state condition, which is regarded, as the temperature readings with a time of about 20 minutes have no change.

Procedure:

Determining the flow friction and heat transfer results in an empty annular tube and comparing them with the available correlations first standardized the experimental setup. Steady state values of friction factors and mean Nusselt numbers for uniform heat flux heating of air were then determined with each of the different mesh-layers thickness which is wound on the inner tube of the annular tube. One can take into consideration that the minimum thickness of mesh layers used ($t=2.3$ mm) is restricted by the available in the market of this kind of mesh materials. While the maximum thickness ($t=11.9$ mm) is restricted by the annular gap thickness of the tested annulus. The characteristics of the augmented annular tubes are shown in table 1.

Table 1 Characteristics of tubes partially filled with mesh screens

| Tube number | D_h (mm) | t (mm) | ϵ | L (mm) | t/δ |
|-------------|------------|----------|------------|----------|------------|
| e | 23.90 | 0.00 | 1.00 | 980 | 0.0000 |
| 1 | 8.840 | 2.30 | 0.987 | .. | 0.1925 |
| 2 | 5.015 | 4.60 | 0.972 | .. | 0.3849 |
| 3 | 3.210 | 7.10 | 0.954 | .. | 0.5941 |
| 4 | 1.702 | 11.9 | 0.910 | .. | 0.9960 |

Flow and Heat Transfer Characteristics

Figure 1.e shows the detail cross-section of the augmented tube under test, and from which the following characteristics can be obtained:

The mean porosity ($\bar{\epsilon}$) of the augmented annular tubes depends on the void fraction of mesh-layers material (ϵ), inner and outer diameters of the annular tubes (D_o , D_i), and the thickness of mesh layers (t). It can be calculated, with the aid of Fig 1-C and the above mentioned definition of porosity as follows:

$$\bar{\epsilon} = 1 - 4t(1-\epsilon)(t + D_i)/(D_o^2 - D_i^2) \quad (1)$$

The free cross-sectional area of the empty (A_{ce}) and augmented (A_{ca}) annular tubes can be calculated respectively as follows:

$$A_{ce} = \pi (D_o^2 - D_i^2)/4 \quad (2)$$

$$A_{ca} = \pi \bar{\epsilon} (D_o^2 - D_i^2)/4 \quad (3)$$

The volumetric diameter defined as four times the volume for flow per unit length divided by the area of wetted surface per unit length was used as the hydraulic diameter. For empty annular tube, it can be calculated as follows:

$$D_{he} = D_o - D_i \quad (4)$$

Based on the hydraulic diameter of the empty annular tube, Reynolds number of the empty (Re_{he}) and augmented (Re_a) annular tubes can be calculated from the following equation,

$$Re_{he} = Re_a = u D_{he}/\nu \quad (7)$$

Correspondingly, Nusselt number of the empty (Nu_{he}) and augmented (Nu_a) annular tubes based on D_{he} can be written in the following form

$$Nu_{he} = Nu_a = h_i D_{he}/k \quad (8)$$

Where h_i is the heat transfer coefficient based on the inside diameter of the annular tube and was calculated as follows

$$h_i = Q/[A_s (\Delta T_i)_m] \quad (9)$$

Where

$$Q = \dot{m} C_p (T_w - T_i) \quad (10)$$

$$A_s = \pi D_i L \quad (11)$$

$$(\Delta T_i)_m = [(T_w - T_i) - (T_w - T_o)] / \ln[(T_w - T_i)/(T_w - T_o)] \quad (12)$$

$$\text{and, } T_w = 1/7 \sum_{i=1}^7 (T_{wi}) \quad (13)$$

Also, the friction factors of empty (f_{he}) and augmented (f_a) annular tubes can be calculated using the following correlation

$$f_{he} = f_a = \Delta P D_{he} / (L \rho u^2/2) \quad (14)$$

In view of the changing cross-section of the augmented tubes, the mean velocity u_m of the fluid space can be written as

$$u_m = u / \varepsilon \quad (15)$$

And the hydraulic diameter of the augmented annular tubes based on mesh layers characteristics can be calculated with the aid of the volumetric diameter defined above, from the following relationship

$$D_{he} = [4/\varepsilon (D_o + D_i)] \{ \varepsilon - \bar{a} (D_o - D_i)(1 - \varepsilon) \} \quad (16)$$

Where (\bar{a}) is the surface area per unit volume of mesh material and is calculated from mesh layer characteristics and found to be $(\bar{a}) = 22 \times 10^3 \text{ m}^{-1}$

Thus the Reynolds numbers for the augmented annular tubes, Re_a formed of the hydraulic diameter (D_{he}) and the g.p.p mean velocity u_m is

$$Re_a = u_m D_{he} / \nu \quad (17)$$

Nusselt number and friction factor of the augmented annular tubes based on the hydraulic diameter (D_{he}) can be evaluated as follows

$$Nu_{he} = h_i D_{he} / k \quad (18)$$

$$f_{ha} = \Delta P D_{ha} / (L \rho u_v^2 / 2) \quad (17)$$

Results and Discussion

In order to standardize the experimental apparatus, test runs of the empty annular tube (smooth annulus without mesh layers) were conducted first and comparing it with the available correlations. Friction factor and mean Nusselt number for uniform heat flux were then determined with each of the different mesh layer thickness, which is winding around the inner tube of the annulus.

Empty Annular Tubes

The empty annular tube turbulent flow friction factors (f_c) measured for air, are plotted in Fig.2 versus Reynolds number, Re_c , and based on the hydraulic diameter of the empty annulus. The figure shows that f_c values are higher than the isothermal friction factor correlation given by Blasius by about 10%. The friction factor of the present study can be correlated with Re_c as follows:

$$f_{ic} = 0.3277 Re_{hc}^{-0.2415} \quad (18)$$

in the range $10^4 < Re_{hc} < 4 \cdot 10^4$ with standard deviation of 4%

Results of heat transfer runs of empty annular tube of this study are presented in Fig.3 along with results of Ref [13]. As shown from the figure, the experimental Nusselt numbers are 5.7 % lower than those suggested by the previous references. The present data are correlated with Reynolds number with a standard deviation of 7% as follows

$$Nu_{hc} = 0.01483 Re_{hc}^{0.8134} \quad (19)$$

All the observation mentioned above indicated that the experimental apparatus and the test procedure used in this study can generate reliable data

Augmented Annular Tubes

The experimental heat transfer and friction results are presented on the coordinates Nu_c versus Re_c and f versus Re_c . These coordinates were based on the hydraulic diameter of the empty annular tube rather than the augmented annular tube in order to directly show the change in Nu and f obtainable with augmented annular tubes over a comparable empty annular tube for a given mass velocity [14]

Turbulent flow friction factors in the augmented annular tube were found to be higher compared to the empty annular tube under the same operating conditions, as seen from Fig.4. The increase in friction factor ranged from 123 to 114% for tube 1 (partially filled with 2.3 mm mesh layer thickness) to as high as 10580 to 7940 % for tube 4 (completely filled with mesh layers 11.9 mm thickness). The other tubes produced friction factor variations intermediate between 114 and 10580%. Although, the turbulent flow friction factor in these tubes was

found to be dependent on mesh layer thickness, it was not independent of Reynolds numbers at high flow rate

The inside heat transfer coefficient for the turbulent flow of air in one empty annular tube and five augmented annular tubes were analyzed in terms of Nu_i - Re_i relationship and Fig. 5 shows this relation for all the augmented tubes. The Nusselt numbers of augmented annular tubes were higher compared to the empty annular tube at the same Reynolds number. The augmented annular tube completely filled with mesh layers (11.9-mm thickness), tubes produced a maximum improvement in Nusselt number of the order of 270%. Whereas the tube augmented by a mesh layer of thickness 2.3 mm, yielded an improvement of 80% only in Nusselt number, compared to the empty annular tube.

To show the effect of mesh layers thickness on the heat transfer, Nusselt number is plotted in Fig. 6 against mesh-layer thickness, represented by the term (t/δ) at different Reynolds number. The figure shows that, Nu increases with t/δ in the range 0.2341 to 0.3849. This is due to the increase in effective thermal conductivity of the whole annulus. While the effective thermal conductivity increases with t/δ . Also, it is shown from the figure that Nu at $t/\delta=0.1925$ is higher than that at $t/\delta=0.3849$. This increase, may be, is due to the increase in disturbance near the surface of the inner tube with respect to the decrease in effective thermal conductivity of the annular gap. The Nusselt number is found to increase with the increase of Reynolds number and the decrease of mesh-layers thickness, while friction factor increases with the decrease of Reynolds number and increase mesh-layers thickness.

In view of changing cross-section of the augmented annular tube, the volumetric diameter, as defined above, is used as the hydraulic diameter D_{ha} in the calculation of Nusselt number Nu_{ha} , friction factor f_{ha} , and Reynolds number Re_{ha} . The f_{ha} - Re_{ha} plot is shown in Fig. 7. The f_{ha} - Re_{ha} plot, shown in Fig. 7 reveals that friction factor in partially filled annular tubes are still differ from that of the empty annular tube. This finding is also exists for the Nu_{ha} - Re_{ha} plot shown in Fig. 8, which indicates that there is an increase of Nu_{ha} for the augmented annular tube over that of the empty annular tube.

Correlations

As expected Nusselt number and friction factor were found to depend on Reynolds number and mesh layers thickness. An attempt was made using the present experimental results as well as the experiences of previous investigators, to correlate the friction factors and Nusselt numbers in terms of Reynolds number, mesh layers thickness to gap thickness ratio (t/δ) , Prandtl number and diameter ratio of annular tube. The following correlations were obtained:

Friction Factor Correlation

$$f_a = 9.303 Re_a^{-0.1} f(t/\delta) \quad (20)$$

Where

$$n_1 = 0.0947 - 0.981 (t/\delta) - 0.545 (t/\delta)^2$$

$$f(t/\delta) = 78.413 (t/\delta)^3 - 51.225 (t/\delta)^2 + 12.635 (t/\delta) - 1$$

$$3000 \leq Re_a \leq 10000, \text{ and } 0.1925 \leq (t/\delta) \leq 1.0$$

The above correlation predicts the values of friction factor, which agrees with experimental results within $\pm 10\%$ as shown in Fig (9).

Heat Transfer Correlation

$$Nu_a = 0.0356 Re_a^{0.81} Pr_f^{0.4} (D_o/D_i)^{0.16} N(t/\delta) \quad (21)$$

Where:

$$N(t/\delta) = 1 + 1.457 (t/\delta) + 2.101 (t/\delta)^2$$

$$3000 \leq Re_a \leq 20000, \text{ and } 0.1925 \leq (t/\delta) \leq 1.0, \text{ and } D_o/D_i = 1.988$$

This correlation was found to be within $\pm 4\%$ of the experimental data values, as shown in Fig (10).

Overall Tube Performance

Bergles et al. [15] outlined several practical criteria for evaluation of the performance of augmented tubes, relative to a smooth tube, and performance ratios based on all criteria have been worked out for the tube side fluid. No published information is available on the application of these criteria for turbulent flow heating of fluids in annular tubes partially filled with porous material (aluminum mesh-layers). In the present work expressions for the performance ratios R_3 , and R_4 have been determined for criteria 3, and 4

Criterion 3:

This criterion aims at improving the heat duty for the case of constant pumping power and for constant basic geometry of the exchanger. The performance ratio R_3 is given by:

$$R_3 = (Nu_a/Nu_s)_{Q, D_o, L, P, T_c, \Delta T_m} \quad (22)$$

For equal pumping power in smooth and augmented tubes

$$A_{cs} f_c Re_s^3 = A_{ca} f_a Re_a^3 \quad (23)$$

For turbulent flow, the friction factor f_c in a smooth annulus is given by

$$f_c = 0.3277 Re_s^{-0.2415} \quad (24)$$

On substituting for f_c in eq.(24), and on simplification, we get:

$$Re_s = (3.0516 f_a Re_a^3 A_{ca}/A_{cs})^{0.3625} \quad (25)$$

Knowing Re_s , the corresponding h_s for the smooth annulus is obtained and R_3 then becomes:

$$R_3 = h_a \text{ at } Re_a / h_s \text{ at } Re_s = Nu_a \text{ at } Re_a / Nu_s \text{ at } Re_s \quad (26)$$

Criterion 4:

This criterion aims at a reduction in the pumping power for equal heat duty and equal surface area. The performance ratio R_4 is given by:

$$R_4 = (P/P_c)_{Q, D_o, D_i, L, \Delta T_m} \quad (27)$$

For equal heat duty and equal heat transfer area

$$Q_1/Q_2 = 1 \quad (28)$$

$$Q_1 = Nu_1 \Delta T_m A k / D_{he} \quad (29)$$

$$Q_2 = Nu_2 \Delta T_m A k / D_{he} \quad (30)$$

$$Q_1/Q_2 = Nu_1/Nu_2 = 1 \quad (31)$$

$$Nu_1 = Nu_2 \quad (32)$$

For turbulent flow, Nusselt number Nu_2 in a smooth annulus is given by

$$Nu_2 = 0.01483 Re_e^{0.845} \quad (33)$$

On substituting for Nu_2 in eq (32) we get

$$Re_e = (67.431 Nu_1)^{1.228} \quad (34)$$

Knowing the values of Nu_1 , the equivalent smooth tube Reynolds number Re_e can be calculated.

Knowing P_2 at Re_e and P_1 at Re_1 , the performance ratio R_1 can be found as follows

$$R_1 = P_1 \text{ at } Re_1 / P_2 \text{ at } Re_e \quad (35)$$

Fig 11 shows the variation of the performance ratio R_1 with equivalent smooth tube Reynolds number Re_e . The augmented tube 1 of mesh-layer thickness of 1.9 mm shows an improvement of 421% in heat transfer at Re_1 nearly equal 10^3 compared to 10% only at Re_e nearly equal to 3000. While tube 4, fully filled of mesh layers (11.9 mm thickness) shows the least improvement of only 20 to 45%, over the entire range of Re_1 . An important observation about these tubes is that, R_1 improves greatly as mesh layers thickness is increased for all the augmented tubes studied. Performance ratio based on criterion 3 was generally found to increase with an increase in Re_1 until they reach maximum values at certain Re_1 values between 10^3 to 2×10^4 , and then decrease with further increase in Re_1 . A similar trend was also observed by [16] of tube roughened by helically coiled ribbons.

The performance ratio based on criterion 4 is plotted in Fig 12, for tubes 1, 2, 3, and 4. This figure shows that a maximum reduction of 76% can be obtained in pumping power for tube 1 while there is a maximum increase in pumping power of 104% for tube 4 (fully filled with mesh layer of 11.9 mm thickness). Again, the change in pumping power is found to be dependent on Re_1 in all the augmented annular tubes used in the present study. The change in pumping power increases with the increase of Reynolds number Re_1 until they reach minimum values at certain Reynolds number Re_1 , $2 \times 10^3 < Re_1 < 2.5 \times 10^4$, and then decrease with further increase in Re_1 .

Finally, it is very important to evaluate the enhancement process as a whole. Therefore, we must calculate the effectiveness (efficiency) index of the process (η), which defines the

ratio between the rate of increase in Nusselt number and the rate of increase in friction factor according to [17] as follows:

$$\eta = (Nu/Nu_0)/(f/f_0) \quad (36)$$

From the experimental results for Nusselt numbers and friction factors, it is easy to calculate the term (η) in case of augmented annular tubes. These results are shown in Fig 13 as a relation between η and Re_{he} , from which it is evident to conclude that the enhancement is more efficient in case of tube 1, partially filled with 2.3 mm mesh layer thickness. In general, from the above discussion, it is observed that tube 1, with minimum mesh layer thickness, perform better than those with mesh layer thickness larger than 2.3 mm.

Conclusions

The following conclusions can be drawn from results of this investigation.

- 1 Friction factor increases with the increase of mesh layers thickness and the decrease of Reynolds number
- 2 Nusselt number increases with both Reynolds number and mesh layers thickness.
- 3 Compared with empty annular tube at constant pumping power and basic geometry, an improvement as high as 420% was obtained in the heat duty using mesh-layers of 2.3 mm thickness ($t/\delta = 0.1925$). While the improvement was as low as 29% in heat capacity using mesh layers of 11.9 mm thickness ($t/\delta \cong 1$) in the entire range of Reynolds number.
- 4 On the basis of constant heat duty and constant heat transfer area, augmented tube with minimum mesh layers thickness ($t/\delta = 0.1925$) performs the best over the entire range of Reynolds number. A reduction in pumping power of about 54.76 % can be achieved using mesh-layers of thickness 2.3 mm ($t/\delta = 0.1925$). While a maximum increase in pumping power of about 104% was achieved with mesh layers of 7.1 mm thickness ($t/\delta = 0.5941$) over the entire range of Reynolds number
- 5 The use of this class of augmentation devices are generally more effective for the case when mesh layers thickness is nearly equal to 2.3 mm ($t/\delta = 0.1925$).
- 6 There are cases, however, when the size of the heat exchanger can not be changed, but its heat transfer must be increased. Under this condition, the use of mesh layers was found to be desirable provided that the high fluid pressure drop is tolerable

NOMENCLATURE

| | | | |
|------------|--|----------------|--|
| \bar{a} | specific area per volume of mesh-layers material, m^{-1} | Q | heat transfer rate, W |
| A | surface area, m^2 | t | mesh-layers thickness, m |
| A_c | cross-section area, m^2 | T | temperature, K |
| D | annular tube diameter, m | $(\Delta T)_m$ | logarithmic mean temp. difference defined by eq (10), K |
| h | heat transfer coefficient, $W m^{-2} K^{-1}$ | u | air mean velocity in annular tube free of mesh-layers, m/s |
| I | electric current, A.r.p. | u_v | air mean velocity in the void space, m/s |
| k | thermal conductivity, $W m^{-1} K^{-1}$ | | |
| L | tube length, m | | |
| P | pumping power, W | | |
| Δp | pressure drop, Pa | | |

Dimensionless Groups

| | |
|----------|--|
| f | friction factor |
| Nu | Nusselt number |
| Pr | Prandtl number |
| Re | Reynolds number |
| R_a | thermal performance ratio, defined in eqn.(26) |
| R_{a1} | thermal performance ratio, defined in eqn.(35) |

Greek Symbols

| | |
|---------------------|---|
| δ | annular gap thickness $(D_o - D_i)/2$, m |
| ε | porosity of mesh-layers material |
| $\bar{\varepsilon}$ | mean porosity of the augmented annular tube (eqn.1) |
| η | effectiveness, eqn.(36) |

| | |
|--------|------------------------------------|
| ν | fluid kinematic viscosity, m^2/s |
| ρ | fluid density, kg/m^3 |

Subscripts

| | |
|------|---|
| a | augmented case based on equivalent diameter of the empty annular tube |
| e | equivalent empty annular tube |
| f | based on fluid properties |
| ha | based on hydraulic diameter of augmented annular tube |
| he | based on hydraulic diameter of empty annular tube |
| i | inside diameter, or inlet section |
| o | outside diameter, or exit section |
| w | wall |

References

1. A.Bejan and C.L Tien, " Natural Convection in a Horizontal Space Between Two Concentric Cylinders With Different End Temperature". *Int J Heat Mass Transfer*, Vol.22, pp.919-927, 1979
2. C.E. Hickox and D.K. Gartling, " A Numerical Study of Natural Convection in a Vertical Annular Porous Layer", *ASME Trans Journal of Heat Transfer*, Vol.68, pp.1-7, 1982
3. M.A. Havstad and P.J. Burns, " Convective Heat Transfer in Vertical Concentric Annuli Filled with a Porous Medium". *Int.J Heat Mass Transfer*, Vol.25, pp.1755-1766, 1982
4. V. Prasad, "Numerical Study of Natural Convection in a Vertical Porous Annulus with Constant Heat Flux on the Inner Wall", *Int J.Heat Mass Transfer*, Vol.29, pp.841-853, 1986
5. A.A. Sultan and E. El-Shafei, " Heat Transfer from Constant Heat Flux Cylindrical Wall to Liquid Flow Through Packed Beds". *Mansoura Engineering Journal (MEJ)*, Vol.16, No.2, pp.50-59, 1991
6. S. Chikh A., Boumedjer, K. Bouhadef and G. Lauriat, "Analytical Solution of Non-Darcian Forced Convection in an Annular Duct Partially Filled With Porous Medium". *Int J.Heat Mass Transfer*, Vol.38, pp.1543-1551, 1995a
7. A.J. Fowler and A. Bejan, "Forced Convection From a Surface Covered With Flexible Fibers" *Int.J.Heat Mass Transfer*, Vol.38, pp.767-777, 1995
8. M.A. El-Nimr and M.K. Alkom, " Unsteady Non-Darcian Forced Convection Analysis in an annulus Partially filled with Porous Media". *ASME Trans Journal of Heat Transfer*, Vol.119, pp.799-804, 1997.
9. G.P. Peterson and C.S. Chang, " Two-Phase Heat Dissipation utilizing Porous Channels of High Conductivity Material", *ASME Trans Journal of Heat Transfer*, Vol.120, pp.243-252, 1998
10. A.R. Martin, C. Saltiel and W. Shyy, "Heat Transfer Enhancement With Porous Inserts in Recirculating Flow". *ASME Trans Journal of Heat Transfer*, Vol.120, pp.458-467, 1998
11. M.S. El-Kady, "Enhanced of Mixed Convection in a Channel with Discrete Heat

- Sources by Using Porous Media", Proceeding of 3rd International Conference of Engineering Research, Vol.1, pp.207-221, Port Said, Egypt, Nov. 1999.
12. M.S. El-Kady, "Effect of Operating Conditions on the Mixed Convection in a Channel with Discrete Heat Sourced and Partially Filled with Porous Media", Proceeding of 3rd International Conference of Engineering Research, Vol.1, pp.222-235, Port Said, Egypt, Nov.1999.
 13. D. Brian Splading and J. Taborek, "Heat Exchanger Hand Design Book", Vol 1, Heat Exchanger Theory, Hemisphere Publishing Corporation, 1983 (Russian Edition, Enegoatomuzat, page 236, 1987).
 14. P. F. Lopina and A.E. Bergles, Heat transfer and pressure drop in tape generated swirl flow of single-phase water, ASME Trans T Heat Transfer, Vol. 91, pp. 434-442, 1969
 15. A.G. Bergless, A.R. Blumen, and J. Taborelc, "Performance Evaluation Criteria for Enhanced Heat Transfer Surfaces", ASME Trans. J Heat Transfer, vol.11, pp.239-243, 1974
 16. S. Nay, and R.M. Raja, "Forced Convection Heat transfer in Smooth Tubes Roughened by Helically Coiled Ribbons". Int J Heat Mass Transfer, vol.30, No 7, pp.1541-1544, 1987.
 17. G.H. Farag, M.H. Hawed, and F.S. Abo-Taleb, "Turbulent Heat Transfer Enhancement in annular Ducts", 3rd Int Conf on Engg-Research, vol.1, pp 193-206, Port Said, Egypt, Nov., 1999

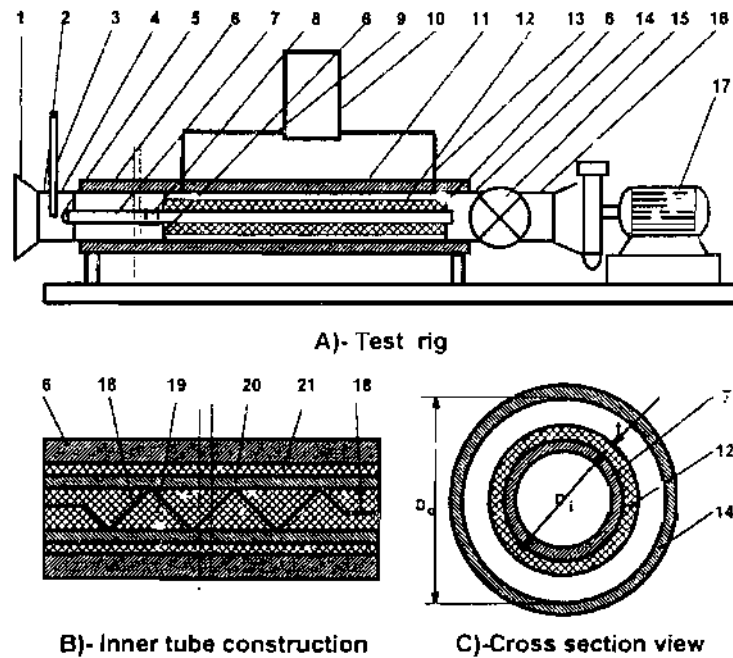

Fig. (1) Details of the experimental set-up

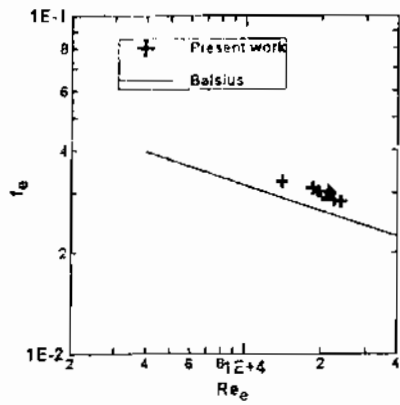

Fig (2) Friction factor versus Reynolds number for empty annular tube.

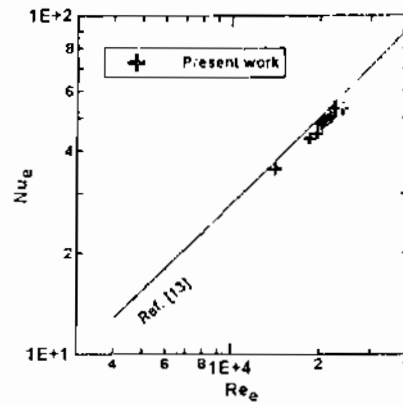

Fig (3) Nusselt number versus Reynolds number for empty annular tube

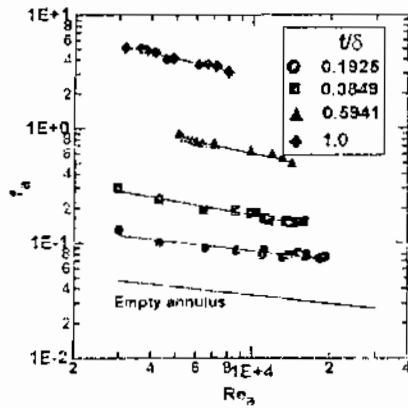

Fig (4) Friction factor versus Reynolds number for augmented annular tubes

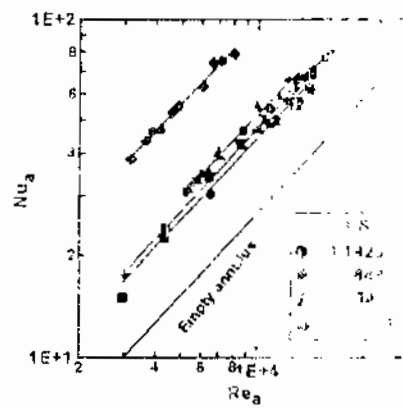

Fig (5) Nusselt number versus Reynolds number for augmented annular tubes

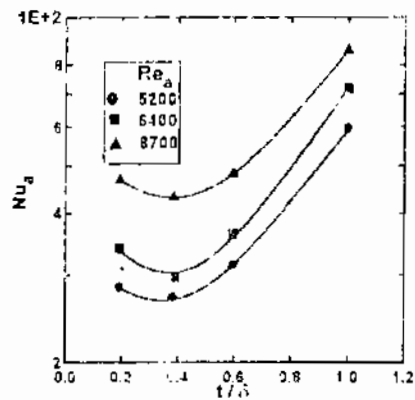

Fig (6) Augmented tube Nusselt number versus mesh layers thickness.

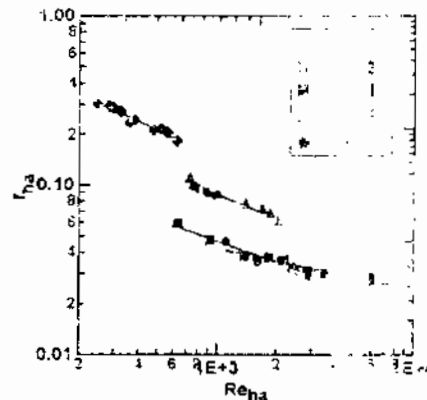

Fig (7) Friction factor versus Reynolds number for augmented annular tubes

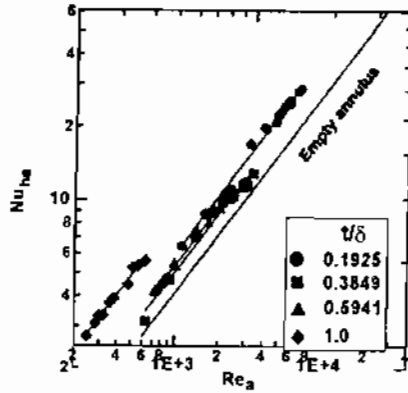

Fig (8) Nusselt number versus Reynolds number for augmented annular tubes

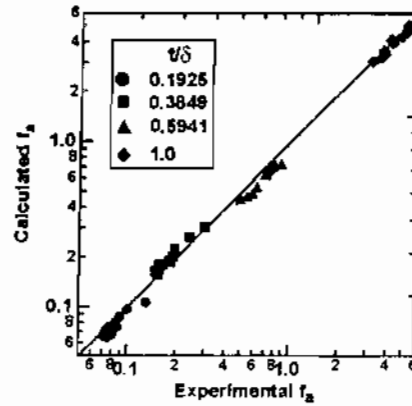

Fig (9) Calculated versus experimental friction factor for augmented annular tubes.

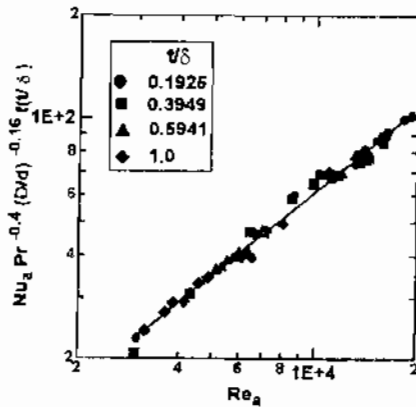

Fig (10) Representation of general equation of Nusselt number for augmented annular tubes.

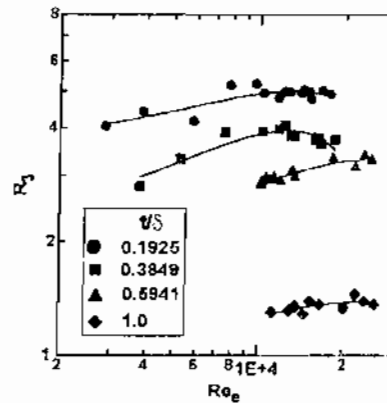

Fig (11) Performance ratio R_3 versus equivalent Reynolds number for augmented annular tubes

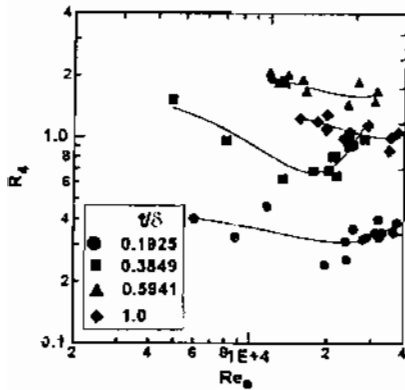

Fig (12) Performance ratio R_4 versus equivalent Reynolds number for augmented annular tubes

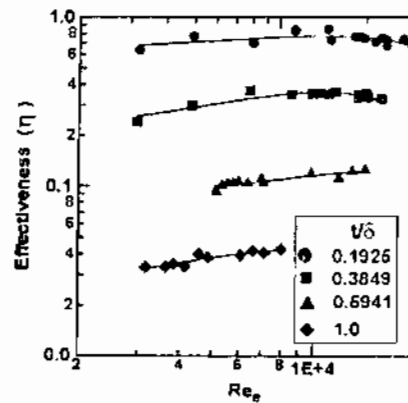

Fig (13) Augmented tubes effectiveness versus equivalent empty tube Reynolds number .