



Pso-Based Optimal Dispatch Considering Demand Response as a Power Resource

التوزيع الأمثل المعتمد علي نظرية أسراب الجسيمات المتماثلة باعتبار استجابة الحمل كمصدر قدرة

I. I. Mansy, A.Y.Hatata and H. W. Elsayyad

Electrical Engineering Department, Mansoura University, Mansoura 35516, Egypt

KEYWORDS

demand Response (DR), Virtual generation, Marginal cost, Power system reliability & Particle Swarm Optimization (PSO)

المخلص العربي:- استجابة الحمل DR عبارة عن مقدار التخفيض في استخدام القدرة الكهربائية عن طريق المستهلك نفسه نتيجة للتغير في سعر الكهرباء مع مرور الوقت او استجابة لأمر المشغل عندما تتعرض مرونة النظام للخطر. في هذا البحث تم أخذ هذا الانخفاض في الاستهلاك كمصدر توليد افتراضي يتم اضافته الي النظام ويمكن التعامل معه علي انه مصدر قدرة للمستهلك. و لعمل التوزيع الأمثل تم افتراض معادلة تكلفة لاستجابة الحمل تشبه كثيرا معادلة التكلفة للمولدات التقليدية لعمل المزيج الأمثل بين كلا مصدري التوليد - التقليدي والافتراضي لتشغيل نظام القدرة. تم استخدام تقنية اسراب الجسيمات المتماثلة PSO للحصول علي التوزيع الأمثل للحمل باعتبار استجابة الحمل انها مصدر قدرة للمستهلك. وتم الحصول على التوزيع الأمثل باستخدام برنامج الماتلاب لحساب تكلفة التشغيل لنظام مكون من 6 بارات وخمسة مولدات واربعة مصادر DR .

Abstract-Demand Response (DR) is the reduction in electric energy by the consumers from their normal consumption due to change in electricity price over time or responding to operator order when system reliability is jeopardized. This paper proposes the reduction in consumption as a virtual generation added to the system and it can be treated as a demand resource for optimal dispatch. DR cost function is proposed which looks like the cost function for conventional generation to make an optimal combination between both DR and conventional generators, to operate the power system. Particle swarm optimization (PSO) technique is used to get the optimal load dispatch considering DR as a demand resource. The optimal dispatch is obtained using MATLAB software by determining the operating cost of 6- bus distribution system with five generators and four DR.

I. INTRODUCTION

Power system operators are searching for alternatives to the traditional generation as it has many restriction of operation. Fuel supply, maintenance costs, unexpected outages and carbon dioxide emission are the most common restrictions of traditional generation. Operators accepted Demand Response (DR) as a demand resource to be one of the alternatives to improve power system reliability, lower electricity price and even prevent blackouts [1-2]. DR can be defined as the changes in electricity usage by end-use customers from their normal consumption patterns in response to changes in the price of electricity over time or the incentive payments designed to

induce lower electricity use at times of high wholesale market prices or when system reliability is jeopardized [2]. Demand-side participation has benefits for individual consumers and the power supplier. Demand response, distributed generation and on site storage are examples for such participation.

DR is considered to be the cheaper resource available of demand participation as it depends on reducing the electrical consumption from the consumer side by switching off non-essential loads or just shifting some domestic loads from peak period to off-peak period by the end user [1]. Any reduction in demand by consumers can be treated as equivalent generation (virtual generation) [3]. Such reduction is beneficial to the supplier as the great role of demand response is peak shaving to flatten the load profile and release the overloading on network components such as generation, transformers and transmission lines. On the other hand, demand response is beneficial to consumers who will receive lower electricity bills and the probability of being curtailed will be reduced. DR as a virtual generation supports the adequacy and security of the power system which leads to raising the reliability of the whole system [4].

It is important to model the consumer characteristics to efficiently utilize the demand response as a demand resource. The customer behaviors can be modeled using an elasticity matrix composed of the price-elasticity of the demand [5]. Many researches show that customer responses

have a positive influence on the power market performance, nodal price, reliability indices and spinning reserve [6–8].

This paper considers the DR as a virtual generation resource that has marginal cost which is a function in electric load reduction magnitude. The way to compute this marginal cost has been proposed. It is able to replace the generation units having a higher marginal cost by comparing the marginal cost of DR and traditional generation. Optimal combined scheduling of traditional generation and virtual generation (DR) was obtained by minimizing the system operating cost with related constraints for each generation. A case study has been proposed to discuss the effect of demand reduction on the operating cost and the transmission losses.

II. DEMAND RESPONSE AND POWER SYSTEM RELIABILITY

Power system reliability is the ability of the electric system to supply the aggregate electric power for consumers at all times, taking into account scheduled and reasonably expected unscheduled outages of system components. System reliability has two basic aspects which are system adequacy and security. Adequacy means the existence of sufficient generation units to satisfy the consumer demand including the facilities necessary to generate power and the associated transmission and distribution facilities required to transport the energy to the end-users. Security means the ability of the system to respond to perturbations that would happen within that system [9].

Demand response can improve power system reliability by aiding the traditional generation resource as DR is considered being a virtual generations. Increasing demand reduction can be treated as an equivalent generation resource which has been added to the power system. By comparing the marginal cost of DR and generation resource; it is able to replace the generation resource having a higher marginal cost by DR resources [3]. The operating cost of the generating units is inversely proportional with the output power as shown in input-output curve of generating unit Fig.1. By applying DR as a power resource, the power needed to supply the demand is reduced and proportionally reducing the operation cost which leads to saving for end consumers.

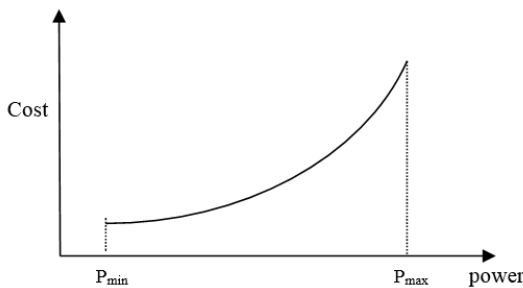

Fig. 1 Input output curve of generating unit

DR can serve as an ancillary resource to help security of power system. By reducing electricity demand at

critical times, when a generator, transformer or a transmission line unexpectedly out of service, DR which is dispatched by the system operator on short time can help returning electric system reserves to pre-contingency levels as DR has no start up time on the contrary of conventional generators.

III. MARGINAL COST OF DR

Total cost of generation (TC) is defined as Fixed cost (FC) plus Variable cost (VC) where FC related to investment and economic profits to be earned independent of the level of power generated and VC is the fuel cost that depends on the level of production. Marginal cost (MC) is the change of TC when output is increased by 1 unit.

In this paper the transformation of the demand reductions of DR into virtual generations of units has been proposed in order to make an optimal combination between conventional generation and DR. The marginal cost of DR as a virtual generation can be calculated as same manner for traditional generation [3].

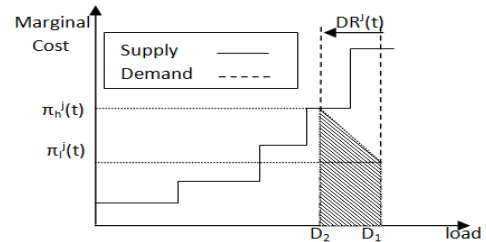

Fig.2 Change in demand curve according to DR.

In Fig. 2 supply and demand curves are shown which denote the marginal cost of generation supply and demand, respectively. The vertical line D_1 of the demand curve shows that no one of the demand resources DR responded to the electricity price or the reliability order. At price $\pi_r^j(t)$ the customer starts to reduce his consumption and $\pi_h^j(t)$ finishes reducing consumption at load D_2 . When the customer responds to the load reduction order as much as $DR^j(t)$ from D_1 demonstrating the characteristics of a typical demand curve. Furthermore, the area below the negative slope represents the DR costs of all demand resources used.

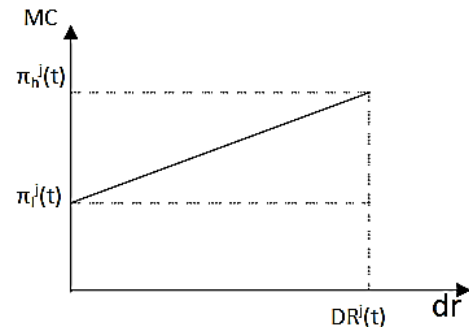

Fig.3 Equivalent marginal cost of demand resources.

Demand reduction can be treated as virtual generation by calculating the marginal cost of the demand reduction. The marginal cost of demand resources is a

function of the load reduction by customers and can be represented as line equation showed in fig. 3[3]:

$$MC^j = \frac{\pi_h^j(t) - \pi_l^j(t)}{DR^j(t)} dr^j + \pi_l^j(t) \quad (1)$$

where MC^j is marginal cost of demand resources, dr^j is the load reduction function, $DR^j(t)$ is the load reduction of customer j specified at time t , π_l^j and π_h^j are the electricity prices when customer j starts and finishes responding to the reduction order, respectively. The linear expression of Eq. (1) can be rewritten, for simplicity, as:

$$MC^j = \alpha^j(t) dr^j + \beta^j(t) \quad (2)$$

$$\alpha^j(t) = \frac{\pi_h^j(t) - \pi_l^j(t)}{DR^j(t)} \quad (3)$$

$$\beta^j(t) = \pi_l^j(t) \quad (4)$$

where $\alpha^j(t)$ and $\beta^j(t)$ are the first order coefficient of the marginal cost function of customer j and can be determined using Eqs. (3) and (4), respectively. The optimal dispatch problem is putting DR cost in a form looks like conventional generation to know the contribution of each generation, including DR, in the optimal solution. Using Eq. (1) the demand resources now can be treated as equivalent generation resources and are then able to compete on equal ground with conventional generation resources for optimal operation of the power system.

IV. OPTIMAL COMBINED SCHEDULING OF GENERATION AND DR

The objective of generation and DR scheduling problem is to minimize the system operation cost, including generation and DR costs, without violating any of the system operation constraints.

A. Problem formulation

The cost function of generation unit i can generally be expressed as a quadratic function of its power output such that [10].

$$C_g^i(P_g^i(t)) = \alpha^i P_g^i(t)^2 + \beta^i P_g^i(t) + \gamma^i s^i(t) + STC^i b^i(t) \quad (5)$$

where $C_g^i(P_g^i(t))$ is the operating cost of a unit i at time t , $P_g^i(t)$ is the output power, $s^i(t)$ is the unit commitment flag which is equal to 1 or 0 depending on if unit i is on or off, respectively, $STC^i(t)$ is the start-up cost, and $b^i(t)$ is the unit beginning flag when unit i turns on from the off state. The cost of DR is represented by the shaded area shown in fig. 2 that can be calculated using Eq. (6).

$$C_{DR}^j(DR^j(t)) = DR^j(t) * \left(\frac{\pi_h^j(t) + \pi_l^j(t)}{2} \right) \quad (6)$$

$$= DR^j(t) * \left(\frac{\pi_h^j(t) - \pi_l^j(t)}{2 * DR^j(t)} DR^j(t) + \pi_l^j(t) \right) \quad (7)$$

Eq. (6) can be rearranged as shown in Eq. (7) to get DR cost function of customer j , represented in Eq. (8) that is similar to generation cost function.

$$C_{DR}^j(DR^j(t)) = \frac{\alpha^j(t)}{2} DR^j(t)^2 + \beta^j DR^j(t) \quad (8)$$

where $C_{DR}^j(DR^j(t))$ is the DR cost for customer j who reduced his consumption by $DR^j(t)$ at time t and the indices i and j denote the generation units and demand resources respectively. The constant term of the generation cost function usually consists of no-load and start-up costs. The DR cost function represents a customer's demand reduction cost of willingness to pay. This virtual cost function is unrelated to the physical characteristics of the power system. If the amount of DR reduction is zero, system operators do not pay any incentives. It can be assumed that the no-load cost of the DR cost function is not required. The start-up cost of the generation is a fuel cost required when a generating unit changes from the off state to the one state. The optimum scheduling of generation and DR can be achieved by minimizing the sum of generation and DR cost such that

$$\min \left\{ \sum_{i=1}^{N_g} C_g^i(P_g^i(t)) + \sum_{j=1}^{N_d} C_{DR}^j(DR^j(t)) \right\} \quad (9)$$

where N_g and N_d are the numbers of generation units and demand resources, respectively. The constraints of the objective function of Eq. (9) can be categorized into two portions: generation and DR. The generation constraints are the load flow balancing equation and generation limits of a unit i respectively,

$$\sum_{i=1}^{N_g} P_g^i(t) + \sum_{j=1}^{N_d} DR^j(t) = \sum_{j=1}^{N_d} CBL^j(t) \quad (10)$$

$$P_{g,min}^i s^i(t) \leq P_g^i(t) \leq P_{g,max}^i s^i(t) \quad (11)$$

where $CBL^j(t)$ is customer j baseline load and $P_{g,min}^i$ and $P_{g,max}^i$ are the minimum and maximum power outputs of a unit i [MW], respectively. DR magnitude $M^j(t)$ is defined as the maximum allowable reduction in demand for customer j , and thus, DR magnitude limits is the constraint of DR given as

$$0 \leq DR^j(t) \leq M^j(t) \quad (12)$$

Transmission losses are a major factor affecting the optimum dispatch of generation [10]. This paper studied the effect of DR on transmission losses as well as optimal dispatch of the proposed test system. Transmission losses can be calculated as a quadratic function of the generator power output from Kron's loss formula (13)

$$P_L = \sum_{i=1}^{N_g} \sum_{j=1}^{N_g} P_i B_{ij} P_j + \sum_{i=1}^{N_g} B_{0i} P_i + B_{00} \quad (13)$$

where B_{ij} are the B-coefficients or loss coefficients that are assumed constant for a specified system.

B. Procedure of proposed pso

PSO is as an optimization tool that provides a population-based search procedure in which individuals called particles change their positions and velocities. Particles fly around in a multidimensional search space and each particle adjusts its position according to its own experience, and the experience of neighboring particles, making use of the best position encountered by itself and its neighbors and the best position is the optimal solution of the problem. The procedures of the proposed PSO are illustrated in the following steps:

- 1) Specify the optimization objective functions define by Eq. (9) and transmission power losses define by Eq.(13).
- 2) Specify variables which are number of particles, acceleration constants and inertia weight factor.
- 3) Initialize randomly the individuals (particles) of the population which is power value according to the limit of each unit. These initial particles must satisfy the practical operation constraints for both generation and DR resources.
- 4) For each particle p of the population, calculate the cost of both resources, conventional generation and DR, and calculate the corresponding transmission losses employing the B-coefficient loss formula.
- 5) Compare each individual's evaluation value with its p_{best} . The best evaluation value among the p_{best} is denoted as g_{best} . The flow chart of the proposed PSO algorithm is shown in Fig.4.

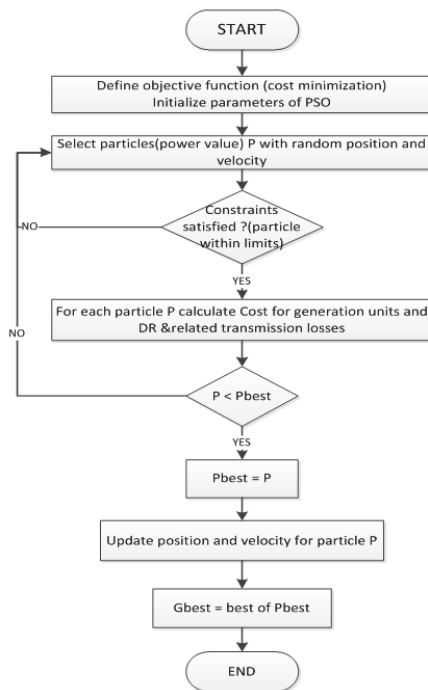

Fig .4 Proposed PSO algorithms

V. SYSTEM UNDER STUDY

The proposed test system shown in fig.5 consists of six buses and five generators (G1 – G5) located on bus 1 and bus 2 with total capacity of 316 MW. Loads (d3 – d6)

are distributed on the load buses (bus 3: bus 6) respectively. Table 1 shows the loads of four load buses from the time period 11–15 h. The characteristics of generation units and the demand resources are assumed in tables (2, 3). MATLAB program is built to apply the optimization process using particle swarm optimization (PSO) to the test system.

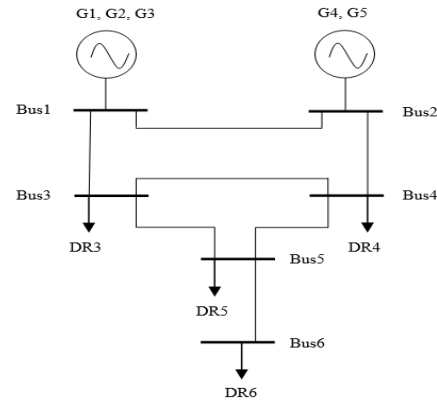

Fig. 5. Test system.

Table 1: system demand [mw]

	11h	12h	13h	14h	15h
load 3	80	85	100	110	85
load 4	70	70	80	80	60
load 5	60	65	70	70	60
load 6	50	50	50	50	45
Total	260	270	300	310	250

Table 2: characteristics of the generation units

	G1	G2	G3	G4	G5
α_i	0	0	0	0	0
β_i	0.05	3	5.25	1.545	1.323
γ_i	44.29	95.542	180	60	72.5
MAX generation	120	36	20	80	60
MIN generation	30	0	0	20	15

Table 3: Characteristics of the demand resources

	DR 3	DR 4	DR 5	DR 6
DR magnitude	10	8	7.5	5
α_j	1.72	2.72	4	3.6
β_j	70	74	130	98

VI. RESULTS AND DISCUSSION

Two cases will be illustrated in the following sections to validate the accuracy of the proposed method.

A. Case 1 (without losses)

Participation rate (PR) is defined as the ratio of j customer's load reductions to the DR magnitude M^j at time t whether this reduction was voluntarily by the consumer willingness or forced by the power supplier [3]. Consumers are assumed to reduce the electric usage by 20% of their DR magnitude (the maximum allowable reduction) that is participation ratio $PR=0.2$ then each load will be reduced by the product of DR magnitude and PR. By applying the characteristic data of generation units and demand resources

listed in tables (2 and 3) to the objective function (9) considering the generators and demand resources constraints, we get the combined schedule of power needed to supply the loads in table (1) as shown in table (4).

Table 4
Optimal combined scheduling of generation and DR in the test system [MW].

		11h	12h	13h	14h	15h
without DR (PR=0)	G1	120	120	120	120	120
	G2	0	10	36	36	0
	G3	0	0	4	14	0
	G4	80	80	80	80	70
	G5	60	60	60	60	60
	cost \$	1033.31	1063.31	1162.31	1214.81	1017.86
with DR (PR=0.2)	G1	120	120	120	120	120
	G2	0	6.4	36	36	0
	G3	0	0	0	7.9	0
	G4	80	80	80	80	70
	G5	60	60	60	60	60
	DR3	0	2	2	2	0
	DR4	0	1.6	1.6	1.6	0
	DR5	0	0	0	1.5	0
	DR6	0	0	0.4	1	0
	cost \$	1033.31	1060.3	1150.54	1200.18	1017.86

Table (4) shows the combined scheduling of generation units (G1-G5) and demand resources (DR3-DR6) for the cases without and with demand reduction (PR=0, PR=0.2). The total cost shown in table (4) is reduced for the case “with demand reduction” compared with the case “without demand reduction”. This is a result of the demand resources with a lower marginal price comparing the generation with a higher price.

To study the effect of increasing the PR, the operation cost for the cases of PR 0.0 – 1.0 in incremental steps of 0.2 are performed and shown in Fig. 6. It can be seen that the operation costs decrease as PR increases due to higher participation from the consumers.

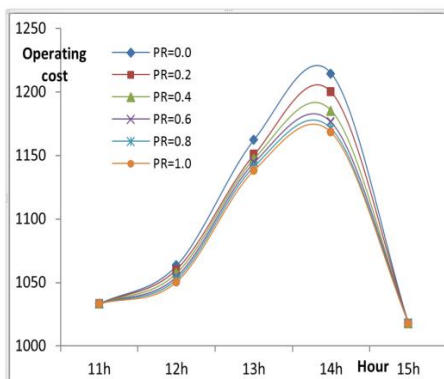

Fig. 6. Operation cost for different PRs

B. Case 2 (including losses)

The same system described above is repeated but in this case losses will be included to the system. Coefficient losses are assumed for the system to study the impact of DR on operation cost and power losses.

$$B = \begin{bmatrix} 0.0048 & 0.0018 & 0 & -0.0004 & 0.001 \\ 0.0018 & 0.0148 & 0.0053 & 0.0039 & -0.0012 \\ 0 & 0.0053 & 0.0113 & 0.0012 & -0.0025 \\ -0.0004 & 0.0039 & 0.0012 & 0.0366 & 0 \\ 0.0010 & -0.0012 & -0.0025 & 0 & 0.0085 \end{bmatrix}$$

$$B0 = [0.0026 \ 0.0022 \ 0.0-0.0007 \ 0.0026]$$

$$B00 = [0.0023]$$

Table [5]

Optimal combined scheduling of generation and DR considering losses [MW].

		11h	12h	13h	14h	15h
without DR (PR=0)	G1	120	120	120	120	120
	G2	3.86	14	36	36	0
	G3	0	0	8.45	18.52	0
	G4	80	80	80	80	73.46
	G5	60	60	60	60	60
	cost \$	1044.91	1075.33	1185.7	1238.54	1023.21
	Losses Mw	3.86	4	4.45	4.51	3.46
with DR (PR=0.2)	G1	120	120	120	120	120
	G2	0.22	10.35	36	36	0
	G3	0	0	2.32	12.37	0
	G4	80	80	80	80	73.46
	G5	60	60	60	60	60
	DR3	2	2	2	2	0
	DR4	1.6	1.6	1.6	1.6	0
	DR5	0	0	1.5	1.5	0
	DR6	0	0	1	1	0
	cost \$	1041.77	1072.16	1170.93	1223.69	1023.21
	Losses Mw	3.82	3.95	4.42	4.47	3.46

Table (5) shows the results for the optimal combined scheduling of generation and DR considering transmission losses. Fig.7 and 8 show the effect of increasing PR from 0 to 1 by 0.2 incremental step on operation cost and transmission losses. It is declared that losses as well as operation cost are reduced by raising PR as the required power to supply loads from generators reduced and consequently reduce the transmission losses.

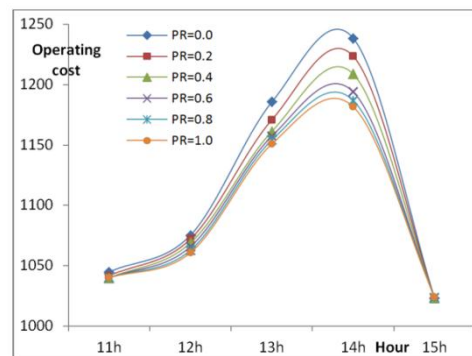

Fig.7. Operation cost for different PRs considering losses

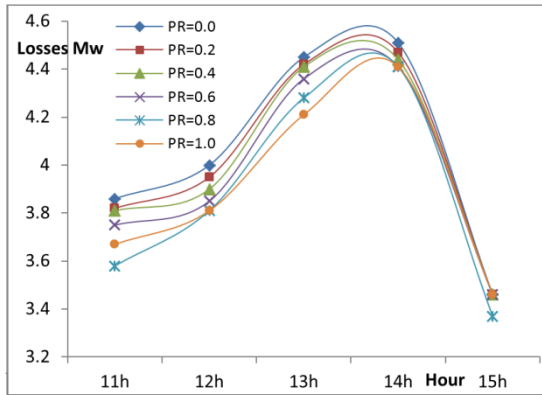

Fig.8 losses at different PRs

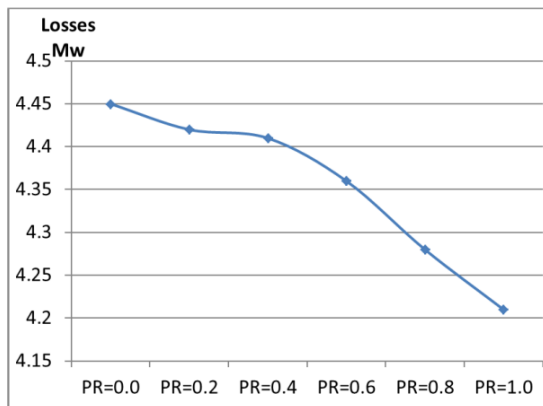

Fig.9 Losses at hour 13 for PR = 0 -1

The curve represents the losses versus the participation rate (PR) at the specific time of hour 13 is shown in Fig. (9). It is noticed that the curve has a negative slope as the losses decreases with the increase of PR.

CONCLUSION

In this paper demand response or actually demand resource has been considered as a virtual generation has a marginal cost that can be calculated in the same manner as conventional generation. Optimal combined scheduling of generation and demand resources was conducted to minimize the operation cost of a power system with the generation and DR constraints developed in this paper. A case study has been discussed to study the effect of DR on operation cost of the power system for the cases with and without transmission losses. Comparing the optimal dispatch for the cases with and without DR it is declared from the results that increasing PR and consequently DR can results in decreasing the operation cost as it has lower marginal cost compared with traditional generation. Results

also indicate that transmission losses decrease with the increase of DR as the power needed to supply the demand decreases.

REFERENCES

- [1] W. Hogan, "Demand Response Compensation, Net Benefits and Cost Allocation: Comments", *The Electricity Journal*, vol. 23, no. 9, pp. 19-24, 2010.
- [2] M. Albadi and E. El-Saadany, "A summary of demand response in electricity markets", *Electric Power Systems Research*, vol. 78, no. 11, pp. 1989-1996, 2008.
- [3] H. Kwag and J. Kim, "Optimal combined scheduling of generation and demand response with demand resource constraints", *Applied Energy*, vol. 96, pp. 161-170, 2012.
<http://dx.doi.org/10.1016/j.apenergy.2011.12.075>
- [4] L. Goel, Q. Wu and P. Wang, "Reliability enhancement of a deregulated power system considering demand response", *Electric Power Systems Research*, vol. 78, no. 10, pp. 1655-1663, 2008.
- [5] D. Kirschen, G. Strbac, P. Cumerayot and D. de Paiva Mendes, "Factoring the elasticity of demand in electricity prices", *IEEE Trans. Power Syst.*, vol. 15, no. 2, pp. 612-617, 2000.
- [6] E. Bompard, Y. Ma, R. Napoli and G. Abrate, "The Demand Elasticity Impacts on the Strategic Bidding Behavior of the Electricity Producers", *IEEE Trans. Power Syst.*, vol. 22, no. 1, pp. 188-197, 2007.
- [7] P. Wang, Y. Ding and Y. Xiao, "Technique to evaluate nodal reliability indices and nodal prices of restructured power systems", *IEE Proc., Gener. Transm. Distrib.*, vol. 152, no. 3, p. 390, 2005.
- [8] S. Chua-Liang and D. Kirschen, "Quantifying the Effect of Demand Response on Electricity Markets", *IEEE Trans. Power Syst.*, vol. 24, no. 3, pp. 1199-1207, 2009.
- [9] R. Billinton and R. N. Allan, "Reliability Evaluation of Engineering Systems", *Concepts and Techniques*, Plenum, New York, 1983.
- [10] H. Saadat, "Power system analysis", 2nd ed. *Mc Graw Hill*; 2004.
- [11] J. Kennedy and R. Eberhart, "Particle swarm optimization", *Proc. IEEE Int. Conf. Neural Networks*, vol. IV, pp. 1942-1948, 1995.